

L200

**ELECTRIC
ANCHOR
LOAD CELLS**

PRESSURE
& LOAD CELLS



ELECTRIC ANCHOR LOAD CELLS

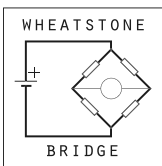

Electrical resistance anchor load cell consists of a ring-shaped stainless steel body which incorporates from 8 to 16 electrical resistance strain gauges in full bridge configuration. This configuration allows low sensitivity to eccentric load.

Typical applications include performance testing of anchor systems in tunnelling or deep excavations. The cell design minimizes the sensitivity to the eccentric load.

Anchor load cells are available in a variety of ranges and diameters. A very stiff distribution plate is supplied, in order to ensure that the load is applied equally over the annular loading surface of the cell.

APPLICATIONS

- Retaining walls
- Deep excavations
- Tunneling
- Diaphragm walls
- Tie-backs
- Struts
- Rock bolts
- Landslides

FEATURES

- Stainless steel body assure instrument long life
- IP68 waterproof protection
- Available digitalization that permits to connect a number of load cells with one signal cable
- High performances for accurate anchors monitoring
- Extended temperature range model available for harsh environments



Meets the essential requirements of the EMC Directive 2014/30/UE

TECHNICAL SPECIFICATIONS

	STANDARD MODEL	EXTENDED TEMPERATURE RANGE MODEL ⁽²⁾
Measurement principle	strain gauges in full-bridge configuration	strain gauges in full-bridge configuration
Full scale capacity kN	from 300 to 2500 kN	from 300 to 2500 kN
Overload	1.5 X Full scale	1.5 X Full scale
Repeatability	< ±0.02% FS	< ±0.02% FS
Stability @1 year	±0.05% FS	±0.05% FS
Sensitivity	see calibration report	see calibration report
Accuracy Pol. MPE ⁽¹⁾	< ±0.5% FS	< ±0.5% FS
Thermal zero shift	< 0.005% FS / °C	< 0.005% FS / °C
Signal output	1.5 mV/V at FS 2.0 mV/V only for 2500 kN FS	1.5 mV/V at FS 2.0 mV/V only for 2500 kN FS
Power supply	from 5V DC to 10V DC	from 5V DC to 10V DC
Bridge resistance	700 Ω FS from 300 to 750 kN (8 strain gauges) 1400 Ω FS from 1000 to 2500 kN (16 strain gauges)	700 Ω FS from 300 to 750 kN (8 strain gauges) 1400 Ω FS from 1000 to 2500 kN (16 strain gauges)
Operating temperature range	-20°C +70°C	-30°C +70°C
Compensated temperature range	-10°C +40°C	-30°C +70°C
Temperature effect on zero	< ±0.002% FS / °C	< ±0.002% FS / °C
Temperature effect at FS	< ±0.002% FS / °C	< ±0.002% FS / °C
Body material	stainless steel 17-4 PH	stainless steel 17-4 PH
Electric insulation	> 5 GΩ	> 5 GΩ
Protection	IP68 up to 100 kPa	IP68 up to 100 kPa

(1) MPE is the Maximum Permitted Error on the measuring range (FSR). In the Calibration Report, the accuracies of the gauge are calculated using both linear regression (\leq Lin. MPE) and polynomial correction (\leq Pol. MPE)

(2) This model is available only under request and under minimum ordering quantity. Minimum delivery time 7/8 weeks.

INSTALLATION SCHEME

Abutment plates (not supplied) are normally designed to suit specific site requirements. In all cases the minimum abutment thickness should be the thickness of the load cell (40 mm).

The abutment plate surface area must be greater than the load cell area. Load distribution plate and load cell have the same central hole diameter.

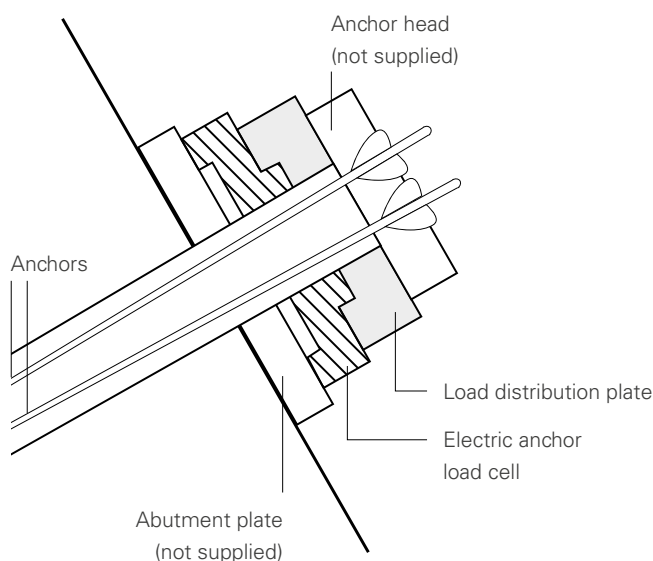

LOAD CELLS

PRODUCT CODE (STANDARD / EXT. TEMP. RANGE)	WORKING RANGE	CENTRE HOLE \ HEIGHT	CENTERING RING	SENSITIVE RING	EXTERNAL DIAMETER
0L204V03000 / 0L204V0300T	0-300 kN	40 mm \ 40 mm	91mm	91mm	155 mm
0L205V05000 / 0L205V0500T	0-500 kN	50 mm \ 40 mm	91 mm	132 mm	155 mm
0L207V05000 / 0L207V0500T	0-500 kN	71 mm \ 40 mm	91mm	132 mm	155 mm
0L207V07500 / 0L207V0750T	0-750 kN	71 mm \ 40 mm	91mm	132 mm	155 mm
0L211V07500 / 0L211V0750T	0-750 kN	110 mm \ 40 mm	135 mm	177 mm	200 mm
0L212V10000 / 0L212V1000T	0-1000 kN	120 mm \ 40 mm	155 mm	197 mm	220 mm
0L216V15000 / 0L216V1500T	0-1500 kN	165 mm \ 40 mm	190 mm	232 mm	260 mm
0L219V18000 / 0L219V1800T	0-1800 kN	190 mm \ 40 mm	230 mm	272 mm	300 mm
0L222V25000 / 0L222V2500T	0-2500 kN	225 mm \ 40 mm	264 mm	306 mm	340 mm

DISTRUBTION PLATES

PRODUCT CODE	CENTRE HOLE \ HEIGHT	EXTERNAL DIAMETER
0L20040PD00	40 mm \ 30 mm	110 mm
0L20050PD00	50 mm \ 30 mm	110 mm
0L20071PD00	71mm \ 30 mm	110 mm
0L20110PD00	110 mm \ 30 mm	155 mm
0L20120PD00	120 mm \ 30 mm	180 mm
0L20165PD00	165 mm \ 30 mm	210 mm
0L20190PD00	190 mm \ 30 mm	250 mm
0L20225PD00	231 mm \ 30 mm	290 mm

Material: zinc plated steel FE 510, $R_y=355 \text{ N/mm}^2$, $R_m=510 \text{ N/mm}^2$

DISTRIBUTION PLATE SECTION

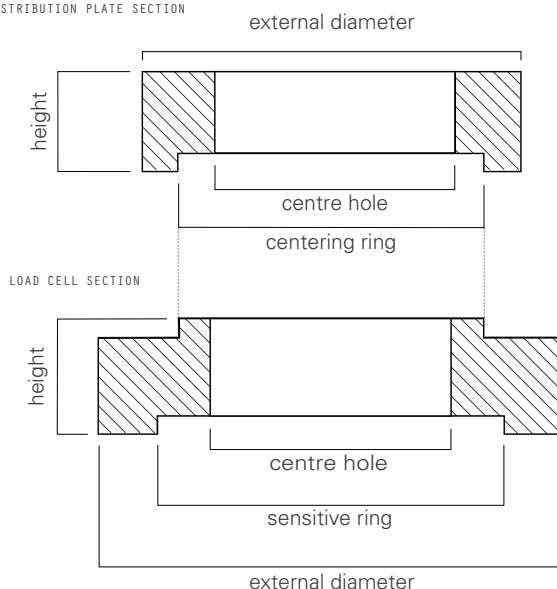

EXAMPLE OF INSTALLATION OF DIGITIZED LOAD CELL

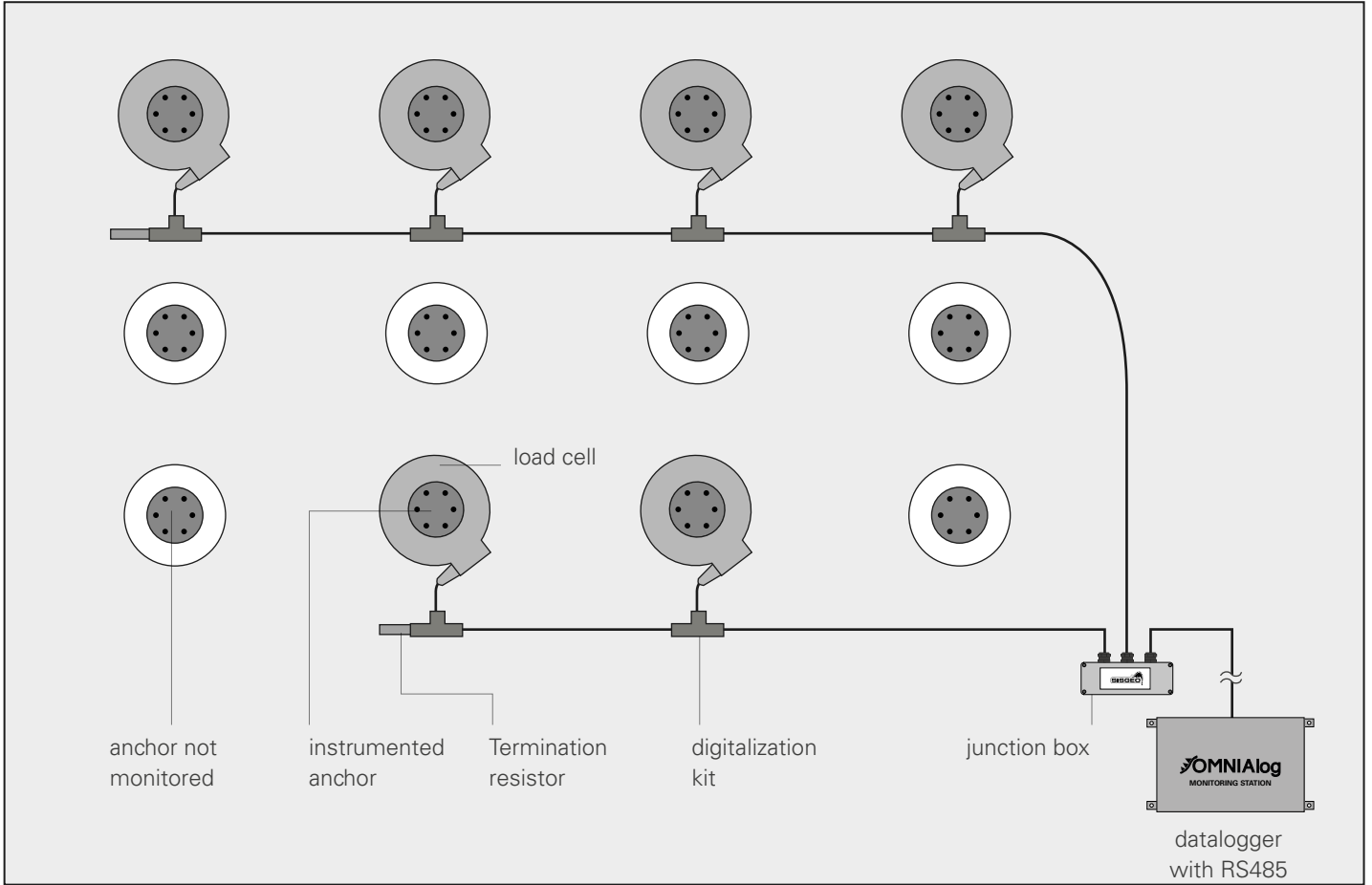

ACCESSORIES AND SPARE PARTS

MIL FLYING CONNECTOR OECON07MV00

Male connector for portable readout direct connection. Installed at factory on instrument cable and supplied with waterproof cap.

SWITCH TERMINAL BOX OEPC0060S00

Available in different sizes to connect up to 6,12,18 or 24 instruments. Equipped with up to four 6-position rotary switches and connector for readout linking.

KIT FOR LOAD CELLS DIGITALIZATION OELCDIG4850

Kit composed by s/steel tube with RS485 digitalization board, connector with T-fitting and 1 meter signal cable.

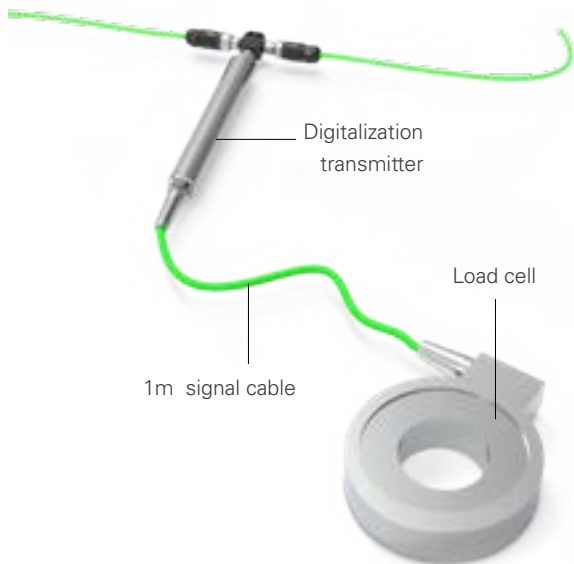

4-20 MA TRANSMITTER OELC420MA00

4-20 mA current loop transmitter (2 wires) installed at factory with 500 mm signal cable protected by steel jacket. IP65 protection upon request protection IP68 up to 200 kPa.

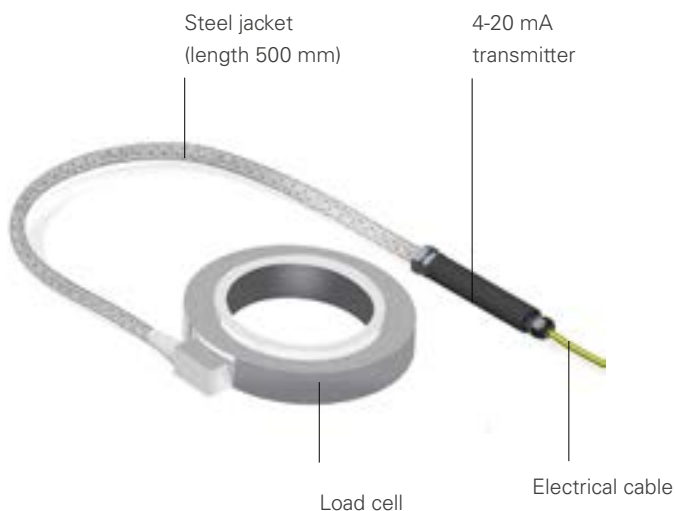

READABLE BY

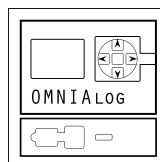
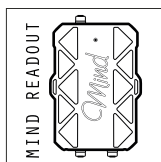
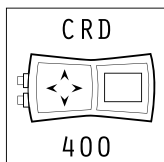

Refer to separate datasheets for further information.

All the information in this document is the property of Sisgeo S.r.l. and should not be used without permission from Sisgeo S.r.l. We reserve the right to change our products without prior notice. The datasheet is issued in English and other languages. In order to avoid discrepancies and disagreement on the interpretation of the meanings, Sisgeo Srl declares that English Language prevails.

SISGEO S.R.L.

VIA F. SERPERO 4/F1
20060 MASATE (MI) ITALY
PHONE +39 02 95764130
FAX +39 02 95762011
INFO@SISGEO.COM

ADDITIONAL SUPPORT

SISGEO offers customers e-mail and phone assistance to ensure proper use of instruments and readout and to maximize performance of the system.

For more information, please refer to the FAQ pages on our website or email us: assistance@sisgeo.com