

klion

Data analysis software for inclinometers and T-REX extensometer

USER MANUAL





INDEX

1. INTRODUCTION	PAGE 5
2. INSTALLATION	PAGE 5
2.1 SET UP	PAGE 5
2.2 START	PAGE 5
2.3 UPDATE	PAGE 6
2.4 UNINSTALLATION	PAGE 6
3. CONVENTIONS	PAGE 7
3.1 AXIS AND GROOVES CONVENTIONS	PAGE 7
3.1.1 AXIS ORIENTATION	PAGE 6
3.1.2 GROOVES ORIENTATION	PAGE 7
3.1.3 REFERENCE WHEEL	PAGE 7
3.2 READINGS CONVENTION	PAGE 8
3.2.1 READINGS	PAGE 8
3.2.2 READINGS NUMERATION	PAGE 8
3.2.3 READINGS SIGN	PAGE 8
3.3 COSTANT	PAGE 8
3.4 READING DEPTH AND MEASURE LENGTH	PAGE 8
3.5 SPIRALLING	PAGE 9
4. USING THE SOFTWARE	PAGE 9
4.1 START	PAGE 9
4.2 MENU STRUCTURE	PAGE 9
4.2.1 FILE	PAGE 10
4.2.2 IMPORT	PAGE 10
4.2.3 EXPORT	PAGE 11
4.2.4 REPORTS	PAGE 11
4.2.5 OPTIONS	PAGE 11
4.2.6 DEMO	PAGE 11
4.2.7 INFO	PAGE 12
5. VERTICAL INCLINOMETER PROCESSING	PAGE 12
5.1 SITE OPTIONS	PAGE 13
5.1.1 ORIENTATION AND POSITION DATA	PAGE 13
5.1.2 BIAS SHIFT CORRECTION (MIKKELSEN)	PAGE 16
5.2 INSERT A NEW MEASUREMENT & MANAGEMENT	PAGE 16
5.3 REPRESENTATION OF MEASUREMENTS	PAGE 18
5.3.1 MEASUREMENTS	PAGE 18
5.3.2 CHECKSUM	PAGE 21
5.3.3 GRAPHIC PROCESSING	PAGE 23
5.3.4 3D CHART PAGE	PAGE 25
5.3.5 DEFORMATIONS OVER TIME	PAGE 26
6. HORIZONTAL INCLINOMETER PROCESSING	PAGE 27
7. SPIRAL METER DATA PROCESSING	PAGE 32
8. T-REX EXTENSOMETER PROCESSING	PAGE 35
9. REPORTS	PAGE 37
10. MEASUREMENT SYSTEM	PAGE 38
APPENDIX 1	PAGE 39
APPENDIX 2	PAGE 40



APPENDIX 3

PAGE 41

APPENDIX 4

PAGE 43

APPENDIX 5

PAGE 45

APPENDIX 6

PAGE 46

Notes on the use of product

For safe and efficient use of the product, please read carefully the following instructions before starting any operation.

Any use of the product other than the one described in this manual shall be considered the user's full responsibility.

The same applies for any unauthorized modifications.

In addition to the hereby listed standards, the user must comply with the provisions of the current legislation regarding personal safety and health together with all other persons in the workplace.

SISGEO is not responsible for any accident, breakdown or other problems due to lack of knowledge and / or non-compliance with the requirements contained in this manual.

Check that the product has not been damaged during the transport.

Verify that the package includes all items as well as any requested optional accessories; if anything is missing, please promptly contact SISGEO.

The user must strictly follow all the operations described in this manual.

Maintenance or repair of the device is permitted only by authorized operators.

These operators must be physically and intellectually suitable.

For information about instrument or to order spare parts, always specify the product information which can be found on the identification label.

When replacing parts, always use ORIGINAL SPARE PARTS.

Symbols



Pay particular attention to the following instruction.

Identification

Instruments can be clearly identified by

- the batch number (written on the Compliance Certificate)
- the serial number (s/n) engraved on the instrument
- the label on the instrument
- the label on the cable

Note

The present Manual is issued by SISGEO in English Language and should be available in other different languages.

In order to avoid discrepancies and disagreements on the interpretation of the meanings, Sisgeo Srl declares that English Language prevails.

All the information in this document is the property of Sisgeo S.r.l. and should not be used or reproduced without permission from Sisgeo S.r.l.

We reserve the right to change our product without prior notice.

For any other information regarding inclinometers, please refer to the International Standard ISO 18674-3.

1. INTRODUCTION

KLION software is able to process data generated from inclinometer surveys and incremental T-REX extensometer surveys.

KLION can be installed on an infinite number of PCs, but can only be started and used if the USB licence key is inserted.

Minimum requirement for the system:

- Windows Vista SP2 or higher operating system
- Microsoft .net framework 4.5.2

2. INSTALLATION

2.1 SETUP

1. Insert the USB flash drive with the installation files.

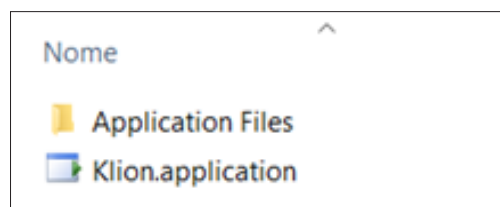

As soon as you insert the USB key, it will start the Setup in "autorun"; if enabled on the user PC.

Otherwise double click on the icon "Klion.application" to start the setup and then follow the instructions.

2. Once the setup is complete, KLION software is installed.

2.2 START

1. Insert the USB hardware license key supplied. At first input, wait, if necessary, that Windows installs the drivers on the key.
2. Start the application using the icon created on the Windows Desktop from the setup.

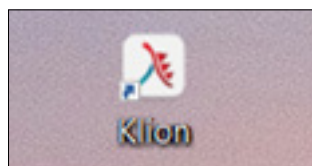

At first start of KLION it will be shown a pop-up where you will be asked to accept the Disclaimer. Once accepted, the program will be opened and will be ready to be used, otherwise it will close.

3. If the startup procedure would fail, be sure to launch the application from a user with admin privileges and that all the security options of the O.S. would allow the execution of the set-up and software's start.

2.3 UPDATE

At each start, with an available Internet connection, the application will verify if any update is available on the server.

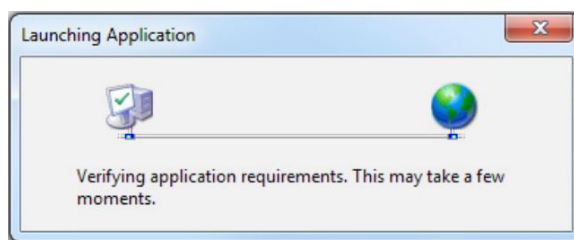

If updates should be available, the user will be given the option to choose whether to install them immediately or at a later startup of the program.

2.4 UNINSTALLATION

1. From Windows "Control Panel" under "Programs and features" open "Install applications"



2. Find KLION software and uninstall

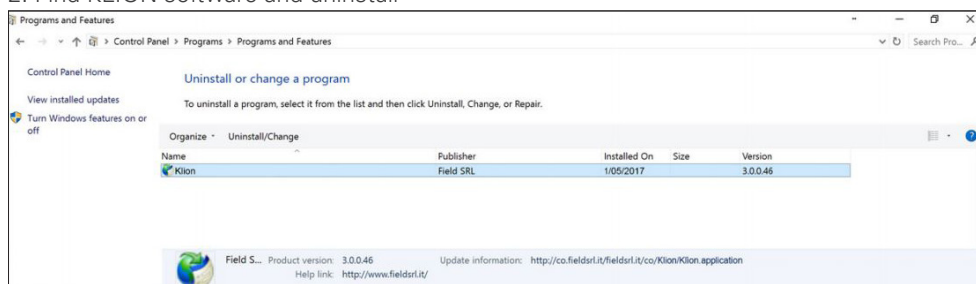

3. CONVENTIONS

3.1 AXIS AND GROOVES CONVENTIONS

3.1.1 AXIS ORIENTATION

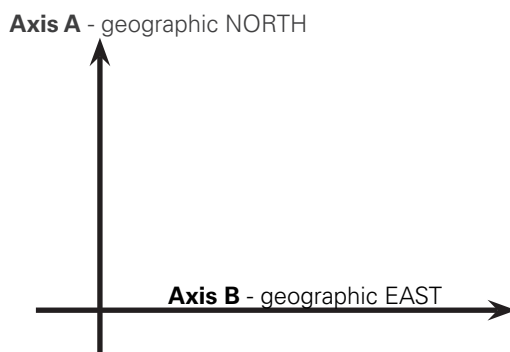

3.1.2 GROOVES ORIENTATION

Once the inclinometer casing is installed, its grooves are identified with numbers 1,2,3,4, clockwise.

Reference groove (groove 1) can be identified as the one closest to geographic North or the one facing the main expected movement, or chosen according to some particular reference of the installation site.

According to standard ISO 18674-3, the azimuth " θ " is the angle formed between the geographic North and the reference groove (groove 1). Azimuth is positive if measurement is clockwise. The following convention is considered:

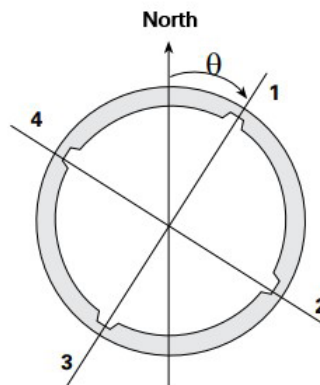

3.1.3 REFERENCE WHEEL

Each inclinometer probe has a reference wheel that is indicated by the manufacturer. The reference wheel is used to ensure the correct orientation of the measurements.

3.2 READINGS CONVENTIONS

3.2.1 READINGS

Using the above grooves identification, readings taken in the casing are identified as follows:

- Probe with reference wheel in groove 1: Reading A1B1;
- Probe with reference wheel in groove 2: Reading A2B2;
- Probe with reference wheel in groove 3: Reading A3B3;
- Probe with reference wheel in groove 4: Reading A4B4

where "A" is the sensor in axis with the wheels, "B" is the sensor perpendicular to them.

3.2.2 READINGS NUMERATION

The readings taken in the casing at different depths are numbered starting from the top also when the measurements are taken starting from bottom casing. For example, if the reading step is 0.5m and the first reading is at 1m depth, the readings will be numbered starting from the top as 1, 1.5, 2, 2.5, 3, etc...

3.2.3 READING SIGN

The reading sign is according to the used probe. It is possible to change the sign convention to adapt to the used probe.

By default is used the following convention:

- *Measurement A: positive (A+) when, with the probe in vertical position, holding still the probe base, the probe is tilted towards the direction of the reference wheel. Measurement negative (A-) when it's tilted towards the opposite direction;*
- *Measurement B: positive (B+) when, with the probe in vertical position, holding still base, the probe is tilted towards the direction at 90° clockwise compared to the reference wheel; measurement negative (B-) when is tilted towards the opposite*

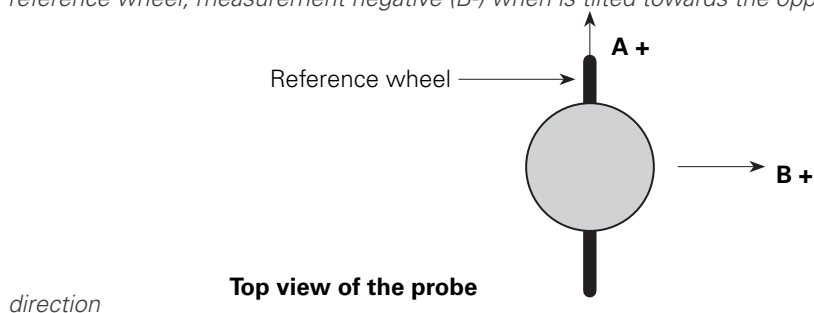

3.3 CONSTANT

The constant "K" represents the probe sensitivity, meaning the multiplier factor of the value *sen a* read from the sensors of the probe. It can be set according to the probe used; by default is set at 20.000.

3.4 READING DEPTH AND MEASURE LENGTH

For a correct survey data interpretation regarding the measure length and survey depths, please refer to the schemes of APPENDIX 5 and APPENDIX 6. In order to fit the depths shown in the program with you application, we suggest to adjust them applying the right offset in the field "1st reading depth".

3.5 SPIRALLING

The program expects the introduction to “casing’s twisting” to compensate inclinometer’s casing grooves orientation variation with depth.

It’s caused by casing’s manufacturing tolerances and/or inclinometer columns installation activities.

The spiralling sign must be established referring to grooves orientation.

By default is used the convention of considering positive the spiralling where the casing twists, at the different depths, clockwise respect to the collar.

4. USING THE SOFTWARE

4.1 START

When you open the KLION software you have the following screen:



4.2 MENU STRUCTURE

Menu consists in several entries, each with its own feature described below.

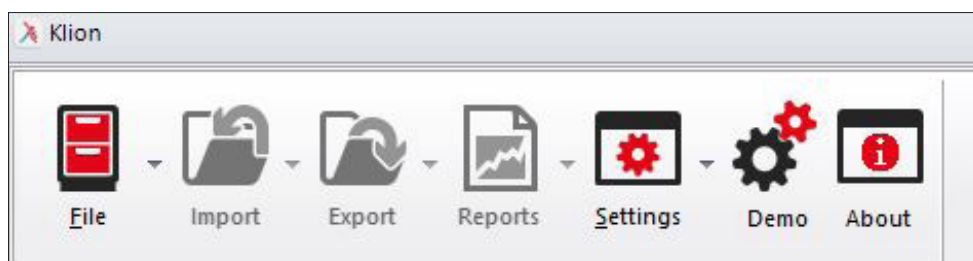

4.2.1 FILE



- **New:** it allows to create a new project. In every project are managed the Sites, the casings in the Site, the inclinometer and spiralmeter measurements taken in the casings;
- **Open:** it opens a project previously created;
- **Save:** saves the current project;
- **Save as:** save the current project leaving the user the freedom to choose the name;
- **Close:** closes the application

4.2.2 IMPORT

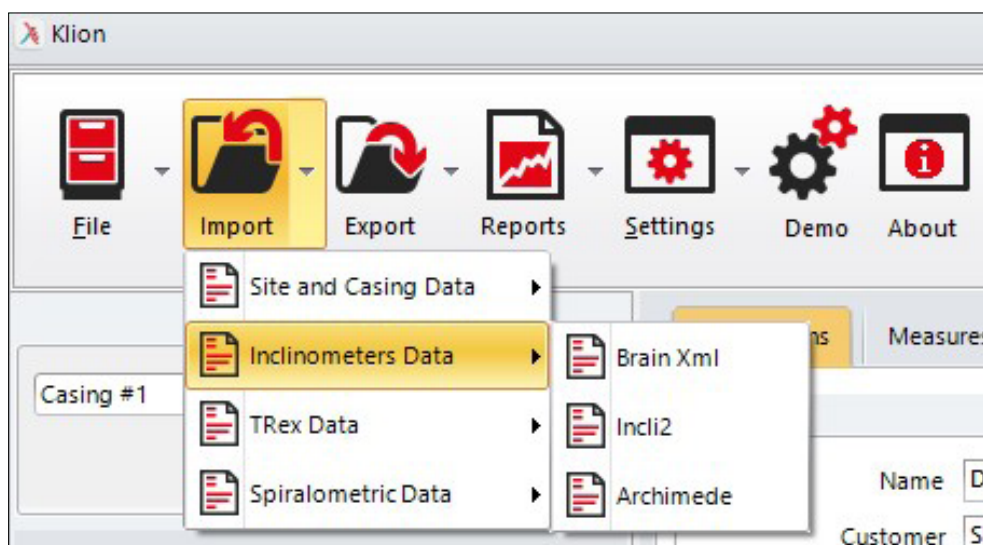

The menu "Import" allows to import, in the current project, data created from external application (B.R.A.IN System XML, INCLI2 software and/or ARCHIMEDE Datalogger). It's possible to import inclinometer, spiralmeter and extensometer measurements. If measurements are taken with B.R.A.IN system and data are exported as XML format, it is possible to import data collected through the APP, such as GPS position, notes taken during the measurements, calibration date, probe serial number, etc...

4.2.3 EXPORT

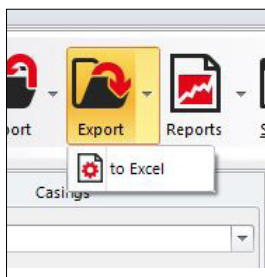

It allows to create an Excel file including all inclinometers data of the current measurement (see next chapters)
In APPENDIX 1 is described how is built the exported Excel file.

4.2.4 REPORTS

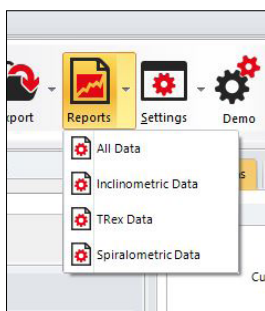

It allows to create reports with data related to a specific project. You can choose whether to create a report with only the inclinometer, spiralmeter or T-Rex data, or a general report including everything.

4.2.5 OPTIONS

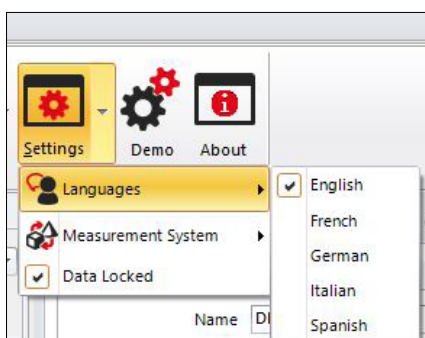

Language: it allows to change the language of the user interface;
Measurements system: it allows to choose whether to use the decimal metric system or the US customary system;
Data locked: selected as default, it blocks the possibility of accidentally modifying the data related to the measurements. Remove the check mark if you want to insert or change manually the data.

If the data are UNLOCKED will be also possible to rename some labels of the software (for details see APPENDIX 3)

4.2.6 DEMO

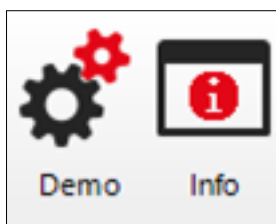

It generates a sample project with casings and measurements based on a demo project with plausible data.

4.2.7 INFO

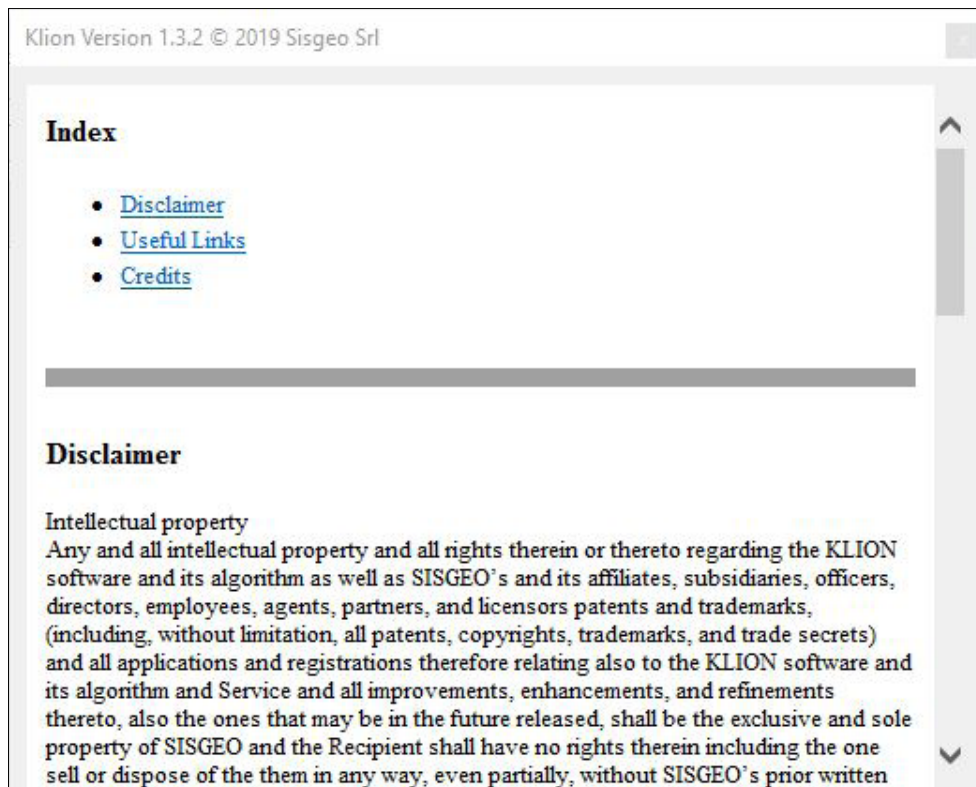

It shows general disclaimers, warnings and useful links.

5. VERTICAL INCLINOMETERS PROCESSING

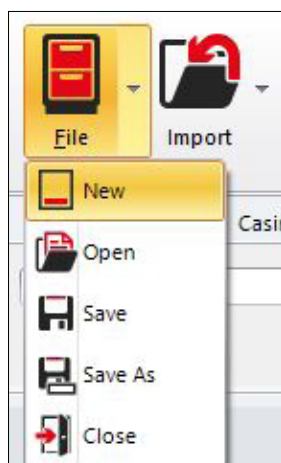

For the creation of a new project:
File → new

It will open a screen with empty project

5.1 SITE OPTIONS

In the dialog boxes you can insert:

Site details:

- Site (*);
- Customer;
- Note (*);

Casing details

- Name (*);
- Orientation (vertical or horizontal) (*);
- Distance from the ground (in meters or in feet, according to the system of measurement used) of the head-casing;

(*): If you import XML files from the B.R.A.IN. system, these information are already included in the XML file. If the information have been previously inserted in the KLION project, importing the XML file will overwrite them and they will be deleted.

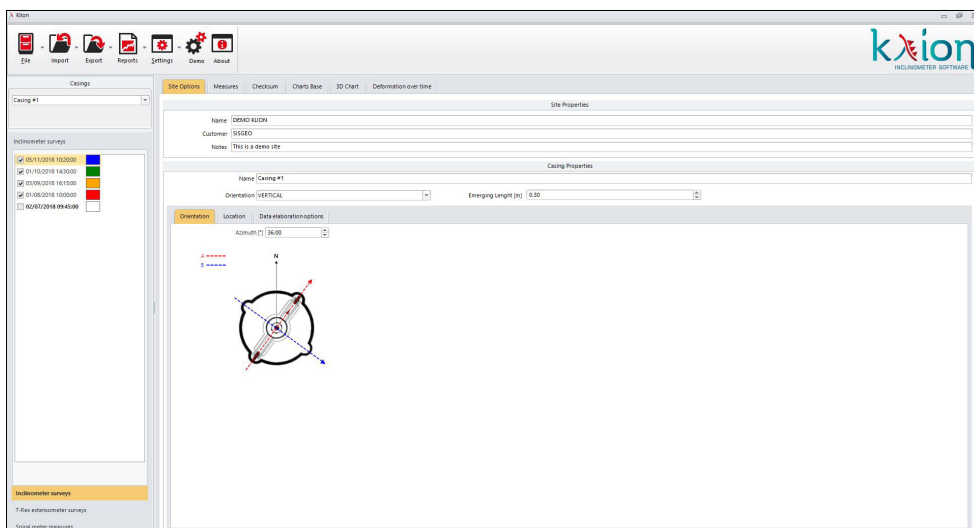

It's possible to manage more inclinometer casing in the same site.

5.1.1 ORIENTATION AND POSITION DATA

Next you can access to three further screens:

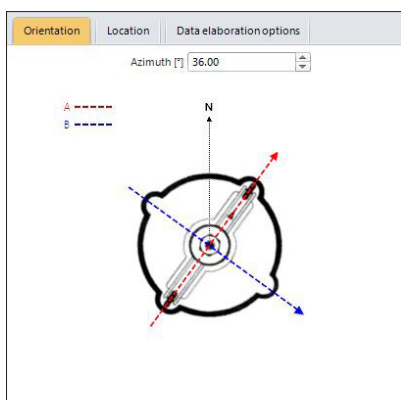

1. Orientation:

Azimuth: measurement according to the convention described earlier. If you don't know the Azimuth, you can leave value 0. In this case, in the graphs, value 0 refers to groove 1, and KLION will process data with an Azimuth equal to 0. The inserted Azimuth can be modified at any moment. At each Azimuth variation, KLION will process again measurements with the set Azimuth.

Inserting Azimuth value, the casing section turns according to the inserted angle. If you import XML files from the B.R.A.IN. system, these information are already included in the XML file.

2. Location:

It's possible to insert the geographic position of the inclinometer casing.

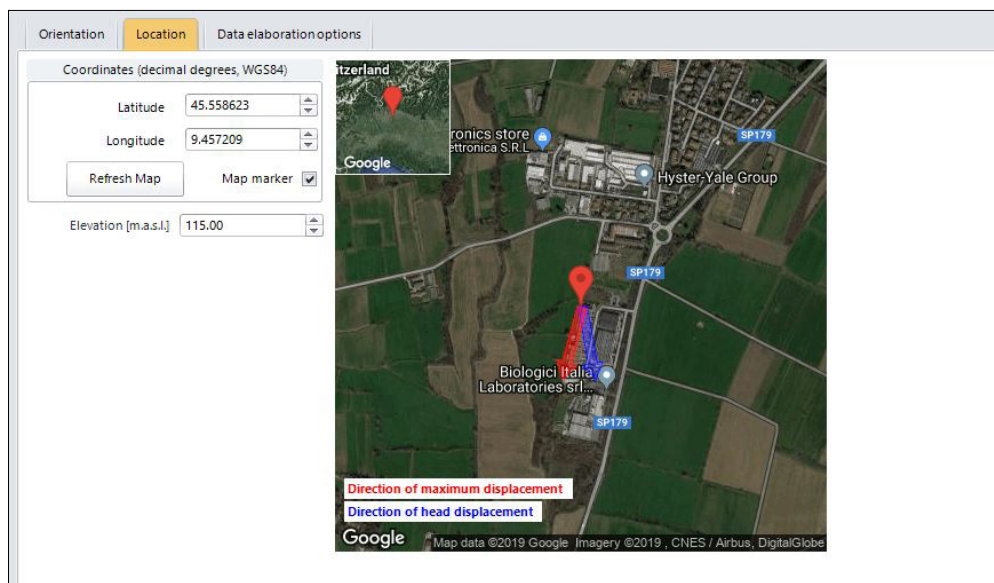

Insert the coordinates of latitude, longitude and altitude a.s.l of the top cap of the casing in order to georeference the casing in a google map.

If you import XML files from a B.R.A.IN system, these information are already included in the XML file. You will find also a button that allows to download, from Google Maps, the static map related to the set coordinates (if connected to internet).

The option "Map Marker" allows you to choose whether to download the map with or without the marker of the precise point defined from the coordinates.

In the map you will find two arrows: the **blue** one shows the **head-casing movement direction** and the **red** one shows the **maximum displacement direction between all the depth detected along the casing**. The two arrows are related to the selected survey.

A click on the map opens Google Maps.

3. Data elaboration options:

It's possible to set several parameters

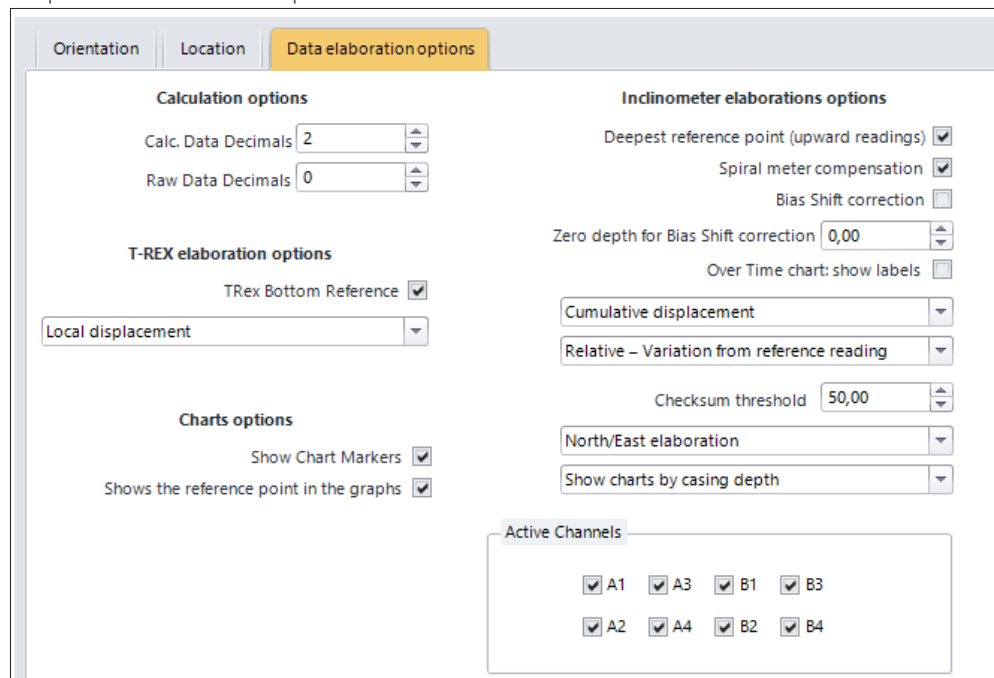

Calculation options:

- Define the data decimals for the elaboration (from 0 to 10);
- Define the data decimals to use from the imported survey data (from 0 to 10);

Inclinometer elaborations options:

- Define if the reference is casing's bottom or the top;
- Include, or not, the spiralmeter compensation;
- Include, or not, the Bias Shift correction (see next chapter);
- Define the Zero Quote for the Bias Shift correction (negative or positive);
- Deformation over time: shows labels. This option allows to choose whether to show, or not, the date in the graphs referring to deformation in time;
- Define the elaboration method (absolute/relative - cumulative/local - NorthEast/A-B)
- Define the threshold for the checksum graphs (default value is 50)
- Show the graphs of "Chart base" by casing depth or by elevation in meters above sea level.

T-Rex elaborations options:

- Define if the reference for the T-Rex extensometers measurements is the casings' bottom or the top;
- Define the elaboration method (cumulative/local)

General charts options:

- Show graphs markers,
- Show the depth reference point in the graphs (as required from ISO18674-3)

5.1.2. BIAS SHIFT CORRECTION (MIKKELSEN)

In agreement with the article “Advances in inclinometer data analysis, FMGM 2003, Oslo – Norway;” written by Prof. Mikkelsen the rotational errors due to small changes in alignment of the inclinometer probe axis are usually very small, less than one degree, and within the precision of the probe system.

Although the mechanical components of the probe are calibrated in such a way that the sensor related to axis A oscillates only in the plane A, it may happen that the mechanical components of the probe are slightly rotated towards the plane B, and therefore the axis sensor A will result less sensitive to the inclinations along the axis B.

This inclination component detected by the axis sensor A constitutes the rotational error that can therefore be defined as the inclination component on the orthogonal plane of a particular reading.

This type of problem (Mikkelsen, 2003) results in a false impression of movement, which may not be really representative of the measurement phenomenon and must be corrected.

The program allows you to apply this correction to the processed data.

The error, sum of random error and systematic error, can lead to overshooting of the order of millimeters (7 to 8 mm on 30 m), which can be significant if combined with Bias and rotation errors. Therefore, the procedure implemented corrects the data.

For every further detail, please refer to Prof. Mikkelsen article available on the web.

5.2 INSERT A NEW MEASUREMENT AND MEASUREMENTS MANAGEMENT

Clicking on the button “new measurement” it’s possible to insert manually the parameters that define the measurements.

To import measurements taken with system not manufactured from Sisgeo, please refer to APPENDIX 2.

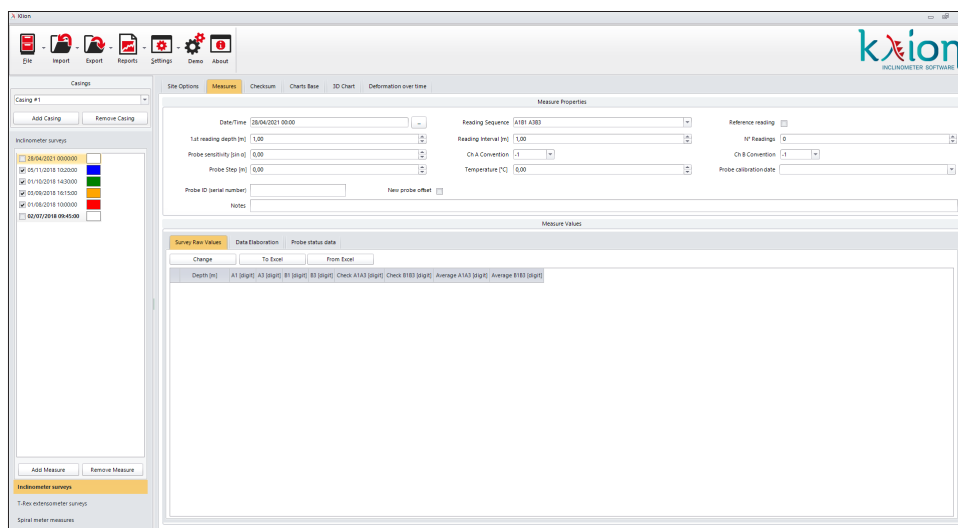

 NOTE: To execute this operation, the data must be unlocked (remove the check from the option “Data Locked.” See OPTIONS paragraph).

Once the measurements are inserted, you get the history of them displayed on the left field of the mask and listed by dates and colors.

The bold measurement represents the reference reading and is highlighted by ticking the “reference reading” option in the measurement mask.

All measurements can be activated and deactivated, and can be edited in terms of representation colors simply by clicking on the matching color.

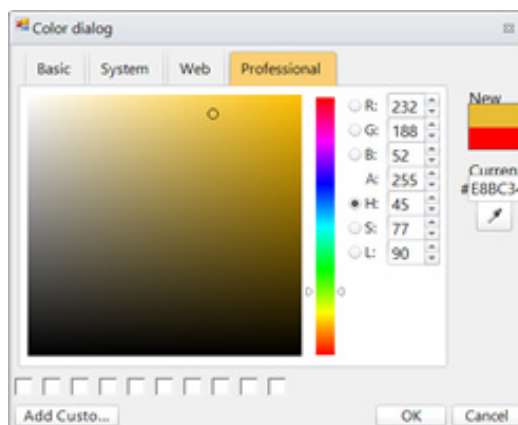

It will open the mask “**Color dialog**” that allows to select the chosen colour.

The list of measurements allows you to:

- Select the measurement to be displayed in the charts base or checksums by ticking the box on the left. Once the box is ticked on the measurement, the color representing the measurement in the charts is also displayed. In the chart, the curve of the measurement highlighted in orange is more pronounced than the others.
- Select the measurement to display the related information in the section dedicated to data and graphs.
- Add (manually) or remove a measurement to the list.

In the case that it is needed to select or unselect ALL the measurements, please proceed as here follows:

- right-click of the mouse on one reading. A selection box will appear with the possibility to select or unselect all the readings

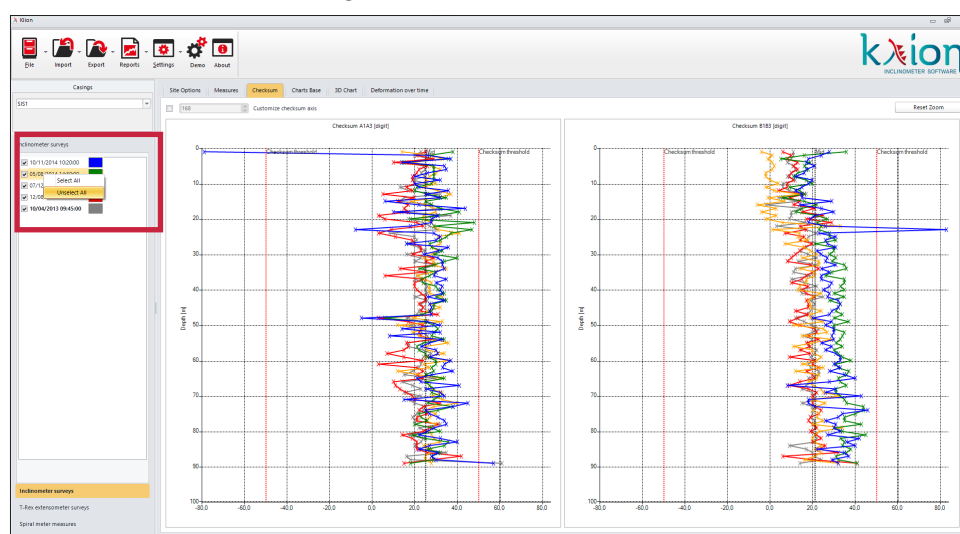

- choosing "Unselect all" will appear a screen similar to the following:

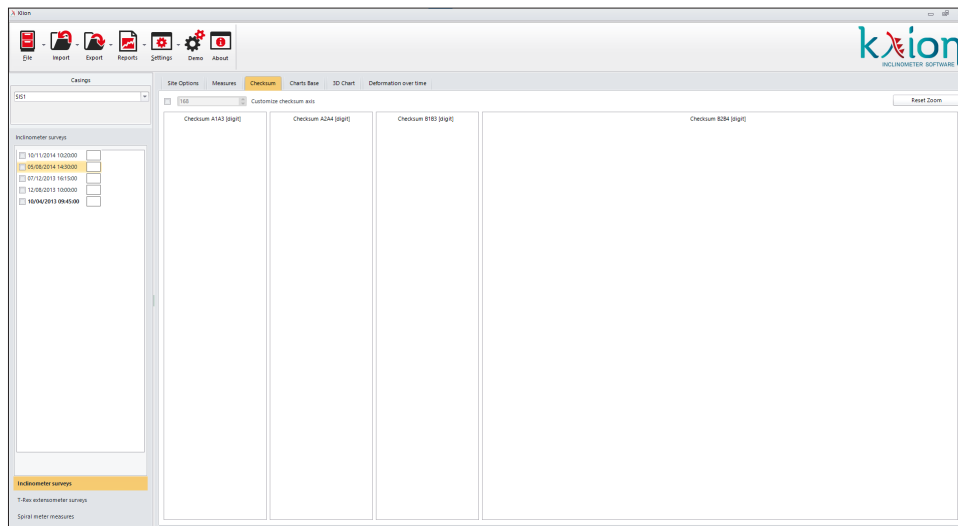

- now is possible i.e. to select one reading in order to show the checksum plot of only one inclinometer survey

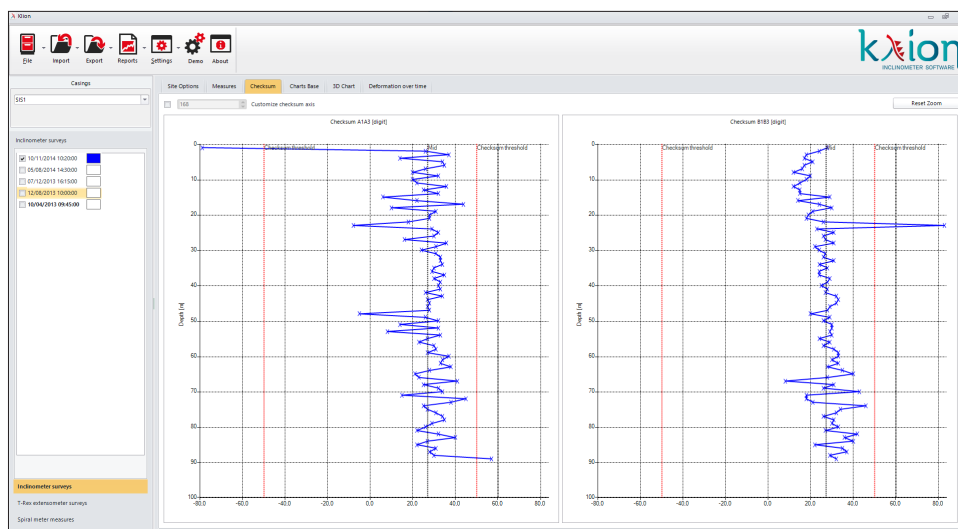

5.3 REPRESENTATION OF MEASUREMENTS

5.3.1 MEASUREMENTS

It is possible to represent measurements by numeric and graphical values; in particular the tab "Measurements" allows to display the numeric values.

You have to select the inclinometer casing and the measurement you want to analyze (it will be highlighted in orange, in the left mask)

The picture below shows the data representation referred to the reading of 03/09/2018 of the inclinometer tube Casing #1.

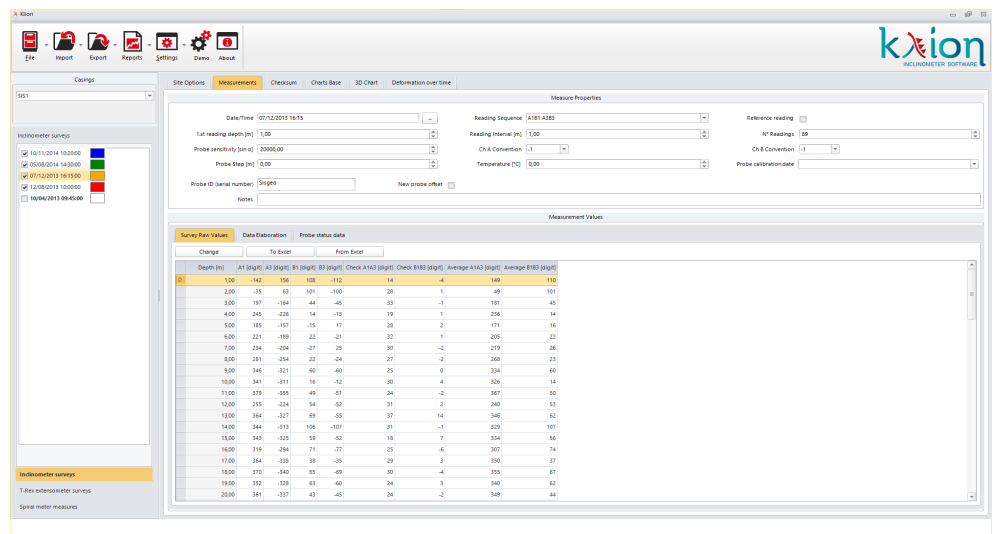

The main parameters of the measurement are shown in the upper part of the screen:

- Date and time of the measurement (*);
- Grooves (keyways) reading sequence;
- If it's the reference reading, or not;
- Depth of the first reading;
- Reading interval is the distance between two readings (*);
- Number of readings in the survey;
- Probe sensitivity (*);
- Conventions on channel A and B. If it's a Sisgeo probe, use -1 / -1;
- Probe step or gauge length;
- External temperature or BRAIN reel temperature;
- Last calibration date of the inclinometer probe (*).
- Serial number of the inclinometer probe (*);
- New probe offset: if this reading is the first reading with a new probe, it will be applied an offset to the data as described in APPENDIX 4
- Any eventual notes (*).

(*If you import XML files from a B.R.A.IN system, these information are already included in the XML file as registered with the BRAIN APP.

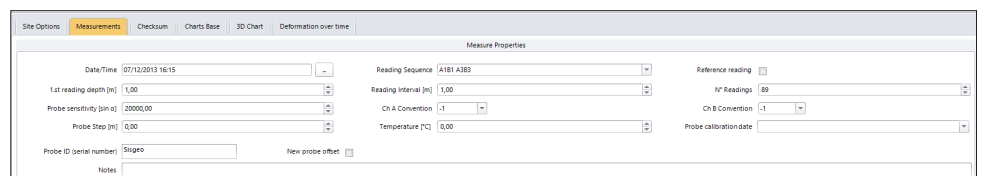

In the lower part of the screen you can find three windows:

- **Survey raw values:** are shown data collected by a survey.

Survey Raw Values									
Data Elaboration									
Probe status data									
Change		To Excel				From Excel			
Depth [m]	A1 [digit]	A3 [digit]	B1 [digit]	B3 [digit]	Check A1A3 [digit]	Check B1B3 [digit]	Average A1A3 [digit]	Average B1B3 [digit]	
1.00	-142	156	108	-112	14	-4	149	110	
2.00	-35	63	101	-100	28	1	49	101	
3.00	197	-164	44	-45	33	-1	181	45	
4.00	245	-226	14	-13	19	1	236	14	
5.00	185	-157	-15	17	28	2	171	16	
6.00	221	-189	22	-21	32	1	205	22	
7.00	234	-204	-27	25	30	-2	219	26	
8.00	281	-254	22	-24	27	-2	268	23	
9.00	346	-321	60	-60	25	0	334	60	
10.00	341	-311	16	-12	30	4	326	14	
11.00	379	-355	49	-51	24	-2	367	50	
12.00	255	-224	54	-52	31	2	240	53	
13.00	364	-327	69	-55	37	14	346	62	

If the data are unlocked (remove the check from the "Data Locked" in "Settings" menu), in the upper part of this section appears 3 buttons that will allow to Change and/or modify the raw data, export the data To Excel file, or import data From Excel file (for details see APPENDIX 2).

Correction

Date: 03/09/2018 16:15

Depth Interval: 1.00 - 89.00

Channels: A1 A3 B1 B3
 A2 A4 B2 B4

Correction: digit % 0.00

Correct

These data can be modified by clicking on "Change" button. The correction is applied defining the depth interval, the channels involved in the change (through their selection/unselection), if you want to consider absolute terms or percentage and the value of those terms.

Once you click "Correct" key, the changes will be applied. A pop-up will confirm the changes.



NOTE: Sisgeo recommends the use of the Change/Correction options only by expert users.

- **Data elaboration:** are displayed the values obtained after data elaboration.

In this section you can choose which kind of elaboration to perform: Relative (the variation from the reference reading) or Absolute (determining borehole profile).

Survey Raw Values | **Data Elaboration** | Probe status data

Relative – Variation from reference reading | Cumulative displacement

Relative – Variation from reference reading

Absolute – Borehole profile

East [mm] | North rel. displ. [mm] | East rel. displ. [mm]

Moreover it's possible to choose whether to execute a processing where you have local variation of the tilt or a cumulative displacement.

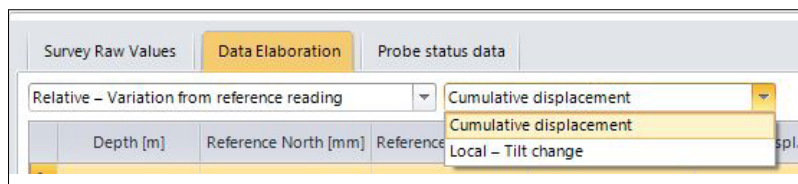

These two choices are repeated also in the screen related to the graphs.

- **Probe status data:** they are imported only through XML file generated from B.R.A.IN and are not used for the elaboration but only for a system health check.

Depth [m]	Temp 1 [°C]	Temp 2 [°C]	RH 1 [%]	RH 2 [%]	Voltage 1 [V]	Voltage 2 [V]	Status 1	Status 2
1.00	13.70	13.50	38.10	37.80	24.10	24.10	stable	stable
2.00	13.30	13.60	38.20	38.10	24.10	24.10	stable	stable
3.00	13.30	13.20	38.30	38.00	24.00	24.00	stable	stable
4.00	12.80	12.80	37.80	38.00	24.10	24.00	stable	stable
5.00	12.70	12.90	38.10	37.90	24.10	24.20	stable	stable
6.00	13.10	13.30	38.20	37.90	23.90	24.00	stable	stable
7.00	12.80	12.90	38.20	37.90	24.20	23.90	stable	stable
8.00	12.90	13.20	37.80	37.90	24.10	24.20	stable	stable
9.00	12.90	13.10	37.90	38.00	24.20	24.20	stable	stable
10.00	12.90	12.90	37.80	38.20	24.00	24.20	stable	stable
11.00	13.20	13.10	38.00	37.80	23.90	24.10	stable	stable
12.00	13.20	13.20	38.20	37.80	24.10	23.90	stable	stable

5.3.2 CHECKSUM

Check-sums should be used as the basis for the acceptance test of the readings and for identifying erroneous measurements.

If readings are incorrect or in doubt, the inclinometer survey shall be repeated.

The check-sum is the sum of the normal and reverse readings taken at the same depth "i". Ideally, the sum is zero since the readings have opposite signs. Basically, however, variations in the positioning of the probe and zero offsets of the probe contribute to non-zero check-sums.

The check-sums can be affected by sediments in the keyways, by inclinometer casing deformation, from the wheel positioning near the couplings, and by the depth positioning error.

In normal circumstances, each combination of probe and guide tube has a unique check-sum signature, which is repeatable in each follow-up measurement. Small variations do not usually indicate a problem, however, spikes in the plot are indicative of inconsistencies in the readings.

SISGEO suggests a check of the inclinometer system in our laboratory in case of check-sum values higher than 50digit.



For any further information regarding the check-sums interpretation, please refer to "Mikkelsen P.E. 2003. Advances in inclinometer data analysis. Proceed. 6th Int. Sympos. Field Meas. in Geomechanics, 15–18 September 2003, Oslo, pp. 555–567, Lisse (Balkema)"

The checksum plots generated by KLION software includes the average value (in black) and the checksum thresholds settled at a value of 50 in red (the threshold value can be changed in "Site Options" -> "Data elaboration options")

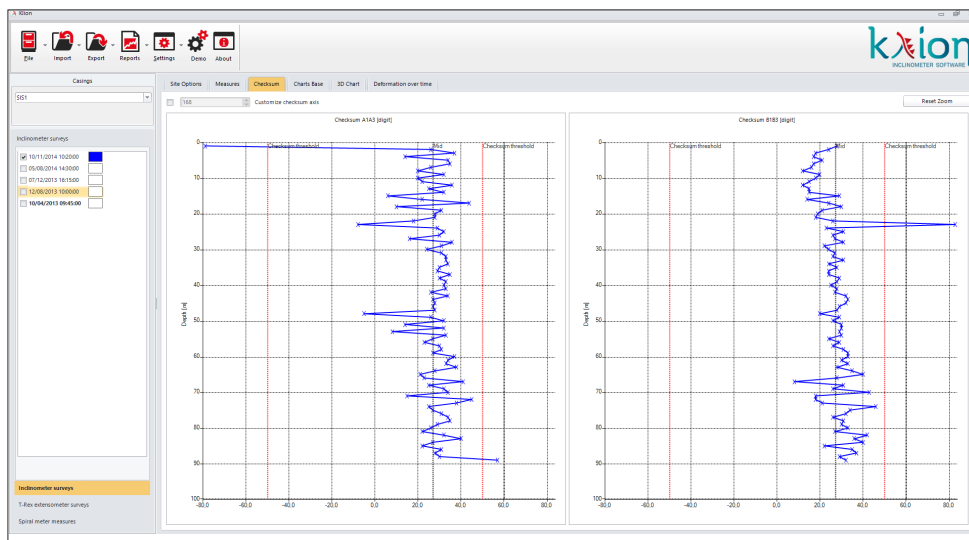

It is possible to compare two or more checksum graphs from different readings just selecting the readings to be compared:

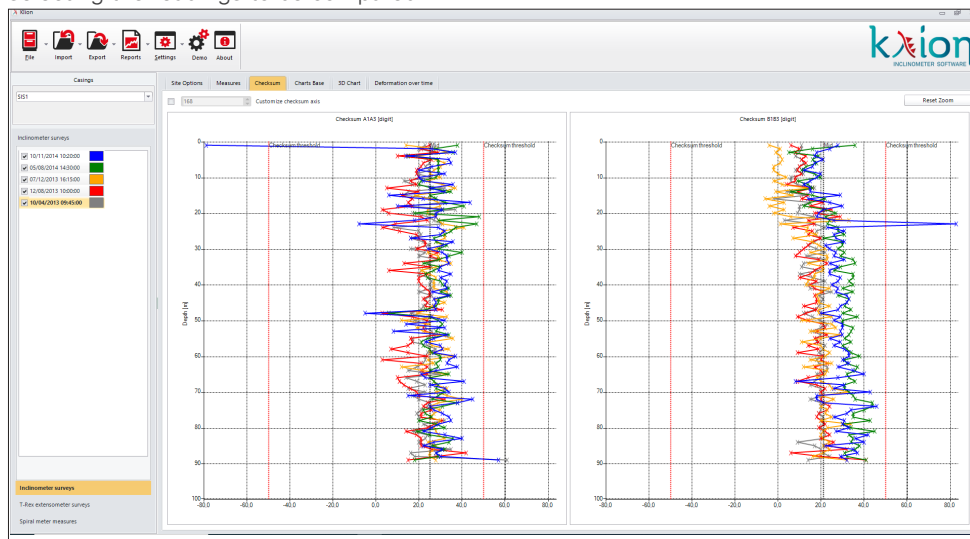

Like any other **KLION graph**, you can zoom on it placing the cursor on the point to be zoomed and using the mouse wheel. The graph can be restored to the initial view clicking on "Reset zoom".

Selecting "Customize X-Axis" allows to set-up the scale of the X-axis for the checksum plot.

Moreover you have the possibility, with a click on the mouse right button, to print and save the graphs in jpeg, PNG or bitmap format.

5.3.3 GRAPHIC PROCESSING (CHART BASE)

The “Chart base” tab permits to choose the type of elaboration and graphic representation of the inclinometer surveys.

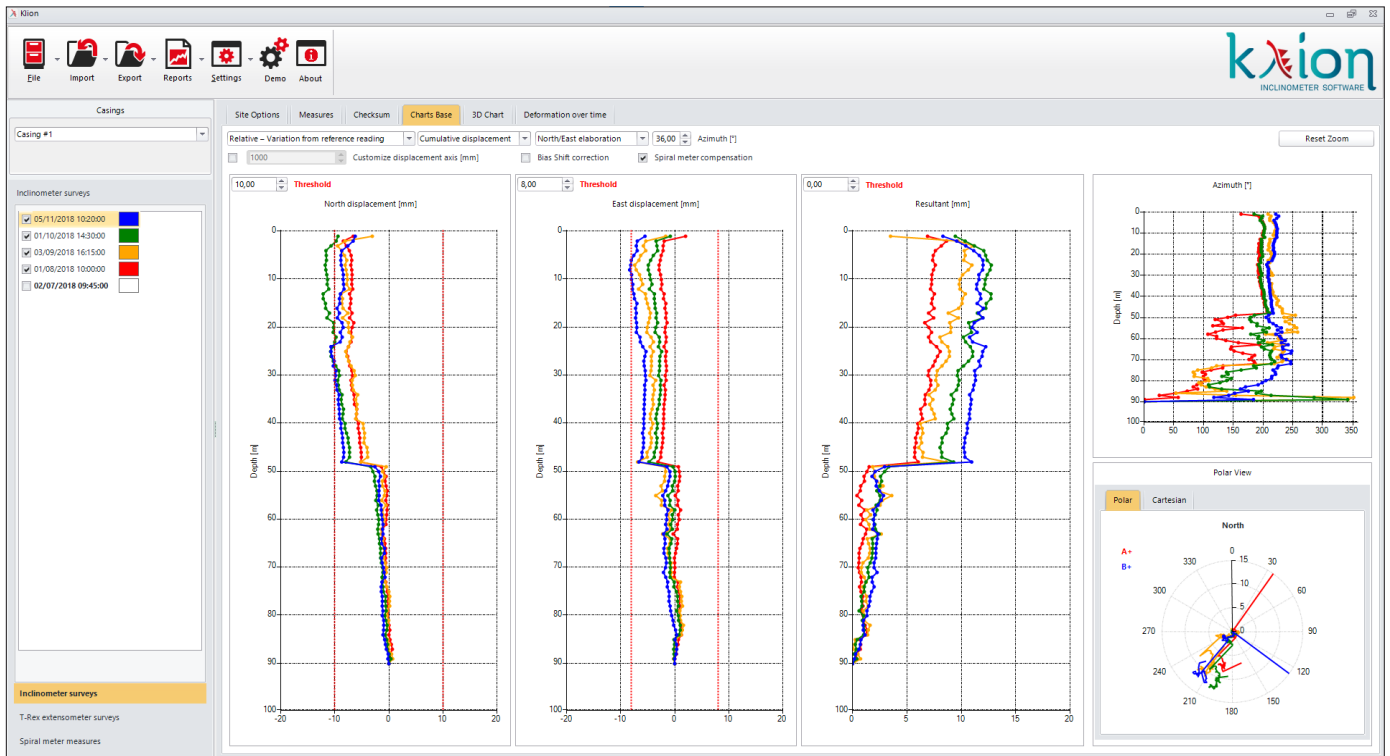

Processing and visualization options are:

- **ABSOLUTE – BOREHOLE VERTICALITY***: Selecting this option you’ll obtain an ABSOLUTE processing and a borehole profile.
- **RELATIVE – REFERENCE Measurement VARIATION***: Selecting this option you’ll obtain a processing RELATIVE to the reference reading.
- **LOCAL - TILT CHANGE***: Selecting this option you’ll obtain a LOCAL and for point processing for each measurement depth in the borehole.
- **CUMULATIVE DISPLACEMENT***: selecting this option you will obtain a CUMULATE processing starting from reference point (bottom borehole or head borehole, selectable from “site option → processing options”)
- **NORTH/EAST elaboration***: selecting this option you will obtain the elaboration of data in NORTH and EAST direction, as requested by ISO 18674-3 standard.
- **A/B channels elaboration***: selecting this option you will obtain the elaboration in the main A e B channels directions of the measuring probe
- **BIAS SHIFT CORRECTION***
Selecting this option you will obtain a processing including the correction suggested from Prof Mikkelsen as described earlier. If this option is NOT selected, it WON’T be applied.

- **SPIRAL METER COMPENSATION***
Selecting this option you will obtain a processing including the Spiral Meter compensation. If this option is NOT selected, it WON'T be applied.
- **AZIMUTH***
- It's possible to change the azimuth of the casing.
- **CUSTOMIZE DISPLACEMENT AXIS**
- Selecting this option you can insert manually the scale used for axis X of the graphs
- If this option is NOT selected the graphs will be displayed with an automatic scale

The options marked with (*) can be settled also in the "Data Elaboration Options" tab.

It is also possible to set-up a graphic threshold for every graphs by inserting the desired value in the "Threshold" field.



Note: set-up a threshold will never generate any alarm.

All graphs have a menu that can be opened using mouse right button, and that allows them to be printed and to be saved as image (jpeg or bitmap format).

A zoom can be applied to the graphs using:

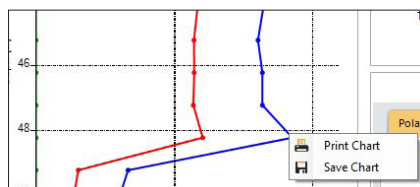

- Mouse wheel
- Keeping the CTRL button pressed (click on the mouse left button at the top of the area you want to zoom and, keeping CTRL pressed, define the box of the area to be enlarged)

Once enlarged, you can "navigate" the graph simply dragging the content with the mouse. With the button "Reset Zoom" at the upper right, you reset all the zoom applied to the masks where it's possible to apply the zoom.

The page "Chart base" will be completed with the graph related to the azimuth (where, on the x-axis is represented the azimuth in degrees and, on the y-axis the depth in m.) and the one related to the same graph but in polar visualization.

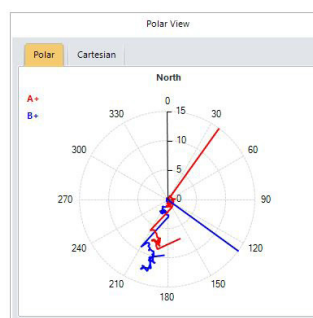
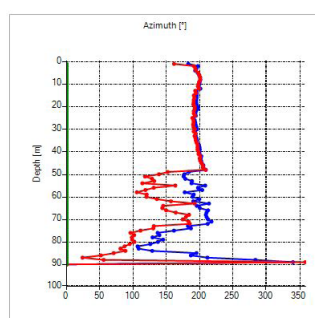

In order to enlarge the “Polar” plot, double-click on the polar graphs and an enlarged windows will be displayed:

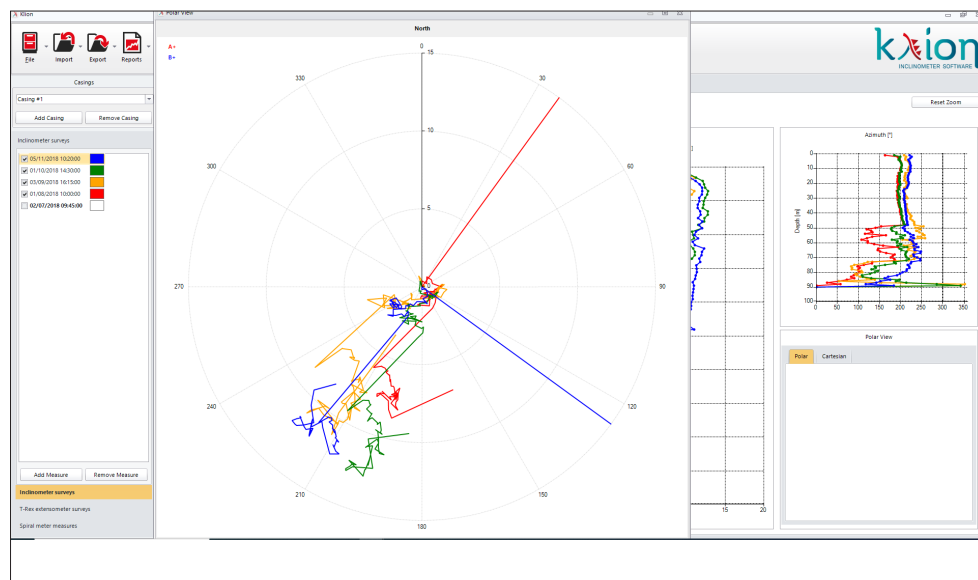

NOTE: in “chart base” page, many labels name can be changed and customized. To do so, please refer to APPENDIX C

5.3.4 3D CHART PAGE

In this section you have the 3D representation of the casing deformations detected. It is possible to rotate the graph in all directions simply using the mouse. Mouse wheel allows to increase or decrease the zoom.

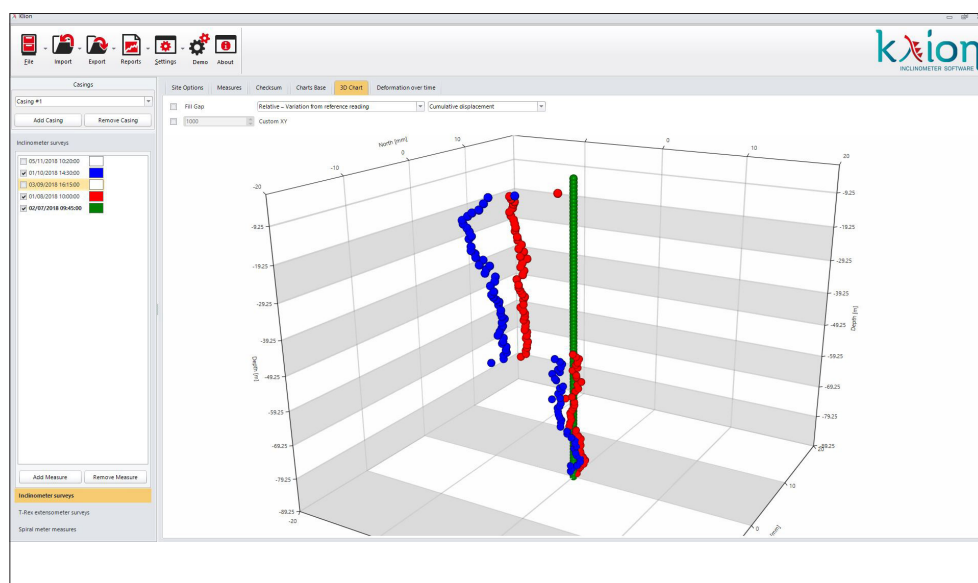

Among the several options already described in “Chart base” there is “fill gap” that allows

to have a continuous representation of the data: it's obtained through measurement's interpolation. The following examples show the effect of this option's activation.

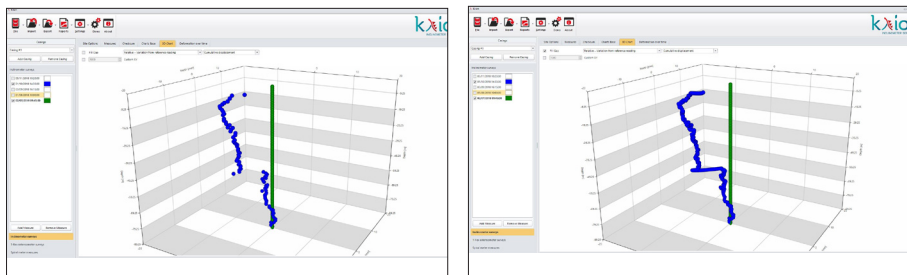

5.3.5 DEFORMATION OVER TIME

This section shows the graph referred to the inclinometer measurement variation over the time.

As standard is set on 3 meaningful depths: the head-casing, bottom-casing and a chosen depth. Depths can, however, be changed anytime.

The depths representation is identifiable by colours : black, red and green.

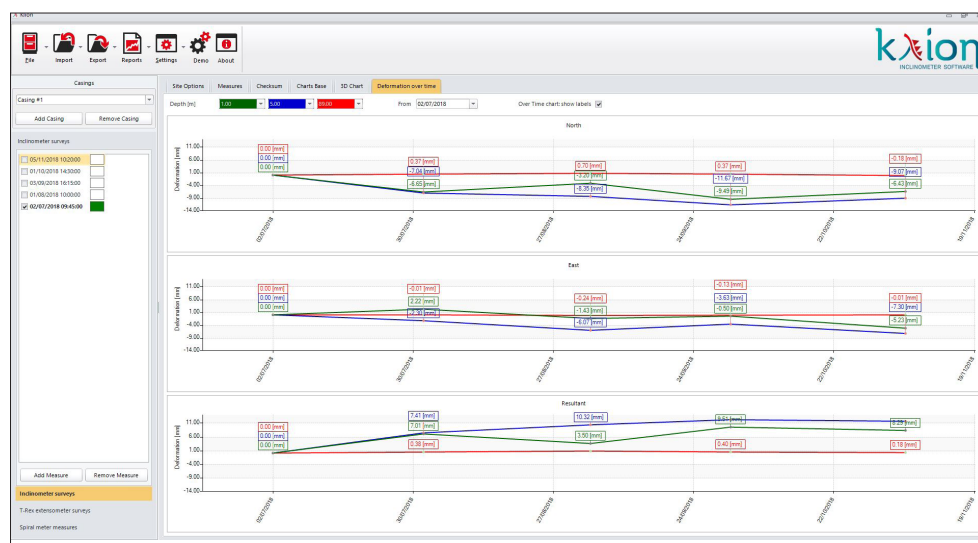

Unchecking "Deformation over time, show labels," the labels, with their displacement values, will be deleted in the graphs, .

It's also possible to apply a filter on dates in order to choose the period to be shown.

In this case, only the measurements executed in the selected period, will be displayed in the graph.

6. HORIZONTAL INCLINOMETERS PROCESSING

KLION allows to process and manage also horizontal inclinometer surveys; the surveys' import is similar to the vertical inclinometer readings previously explained. At program start you need to set the new project activating the option New in the "File" Menu

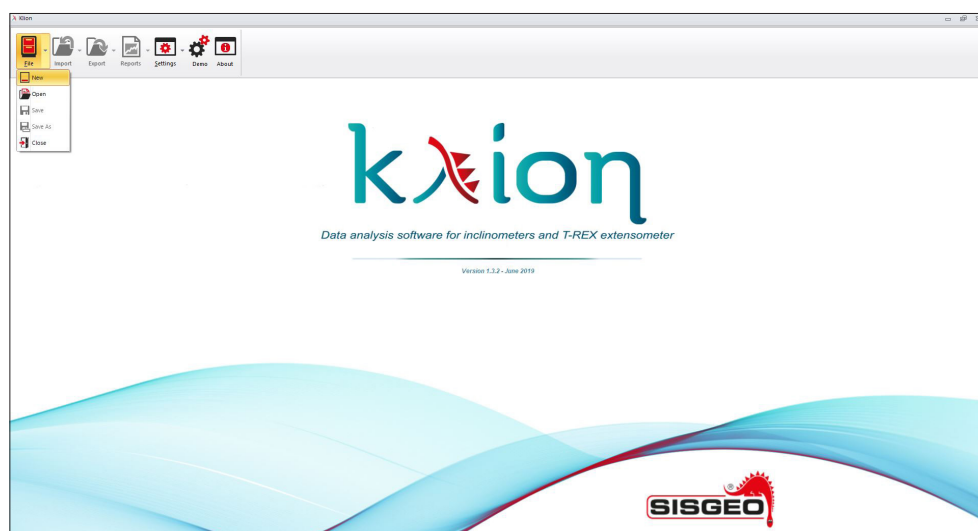

Once filled the blanks of general data, as seen before for the vertical casings, it needs to be defined the HORIZONTAL orientation in the "casing properties".

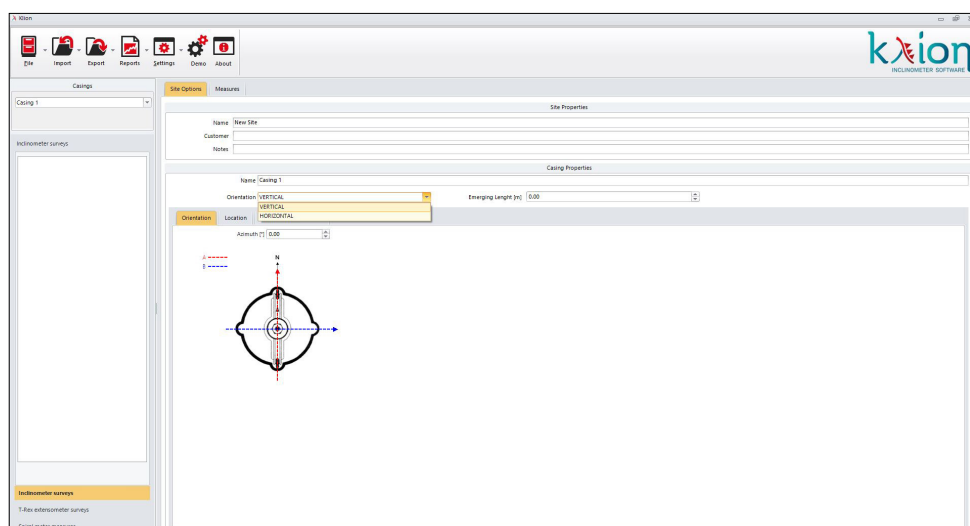

Now it's possible to import horizontal inclinometer surveys from the Import menu, Inclinometer data and choose whether to import from Incl2, Archimede or B.R.A.IN (file XML).

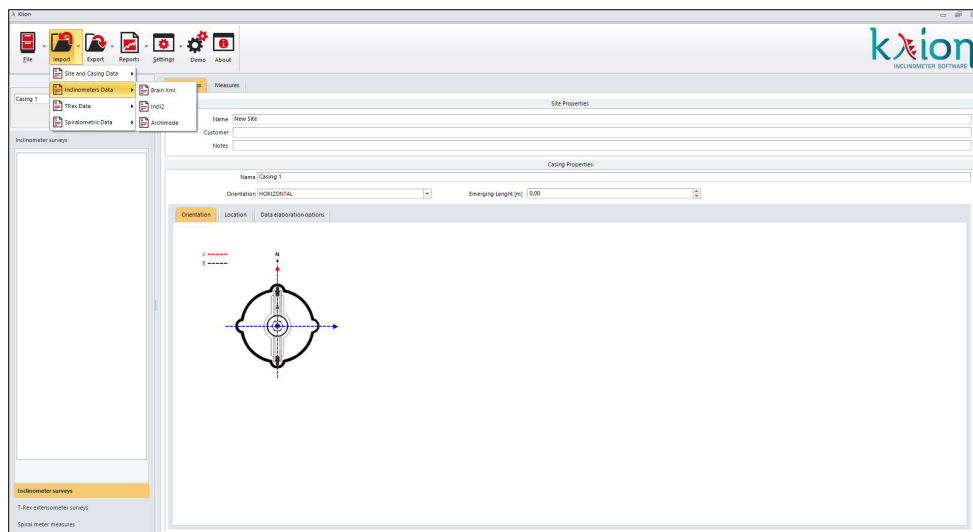

Once imported the file, the usage and processing are similar to the vertical inclinometers.

An additional option is available only for horizontal inclinometers: inserting the “Tube entrance vertical offset” for every measurement (survey). This will allow, in the case of topographic survey of the entrance of the orizontal casing, to obtain charts and data corrected with the altitude offset between the reference reading and the follow-up surveys.

6.1 MEASUREMENTS

The layout of the “Measurements” page for horizontal measurements is similar to the page for vertical measurements.

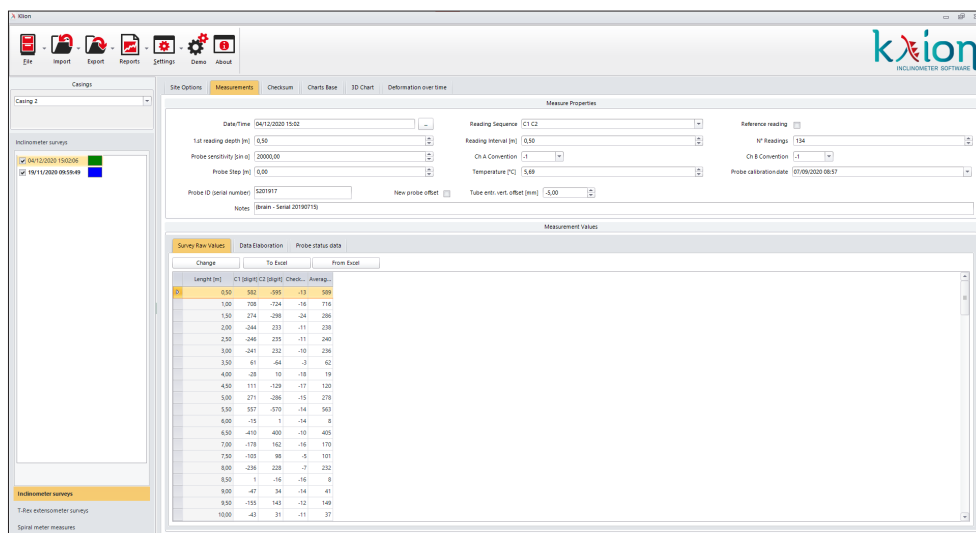

If it is needed to insert the vertical absolute offset between the reference reading and the actual reading (obtained with topographic survey), the value has to be inserted in the “Tube entr. vert. offset” space, directly in mm.

Measure Properties	
Date/Time	04/12/2020 15:02
1.st reading depth [m]	0,50
Probe sensitivity [sin a]	20000,00
Probe Step [m]	0,00
Probe ID (serial number)	S201917
Notes	[brain - Serial 20190715]
Reading Sequence	C1 C2
Reading interval [m]	0,50
Ch A Convention	-1
Temperature [°C]	5,69
Tube entr. vert. offset [mm]	-5,00



Note: In order to use in the best way this option, it is suggested to take the horizontal readings from the tube entrance and to unselect "Deepest reference point" in Data elaboration options page.



Note: The sign convention for this option is negative for settlements and positive for heave.

6.2 CHECKSUM

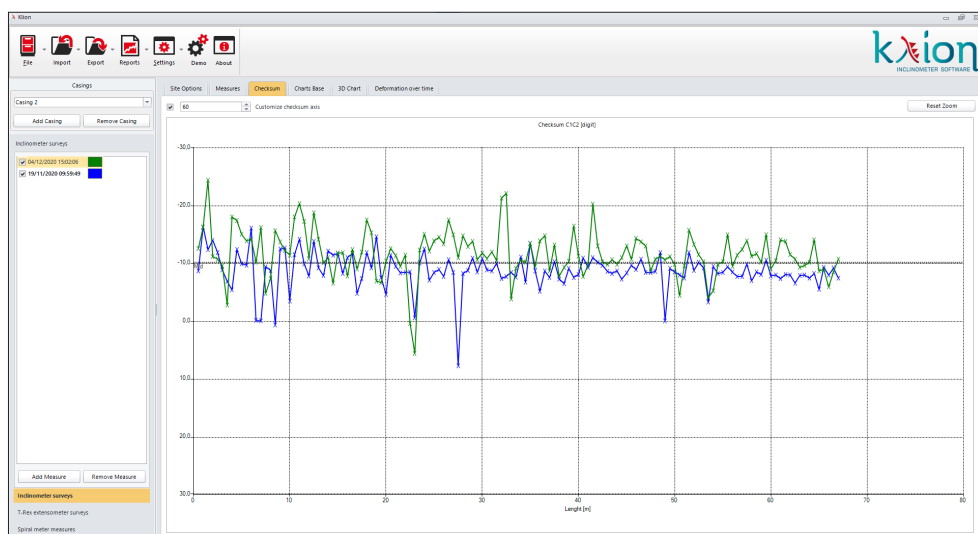

6.3 CHART BASE

The charts can be displayed with or without thresholds.

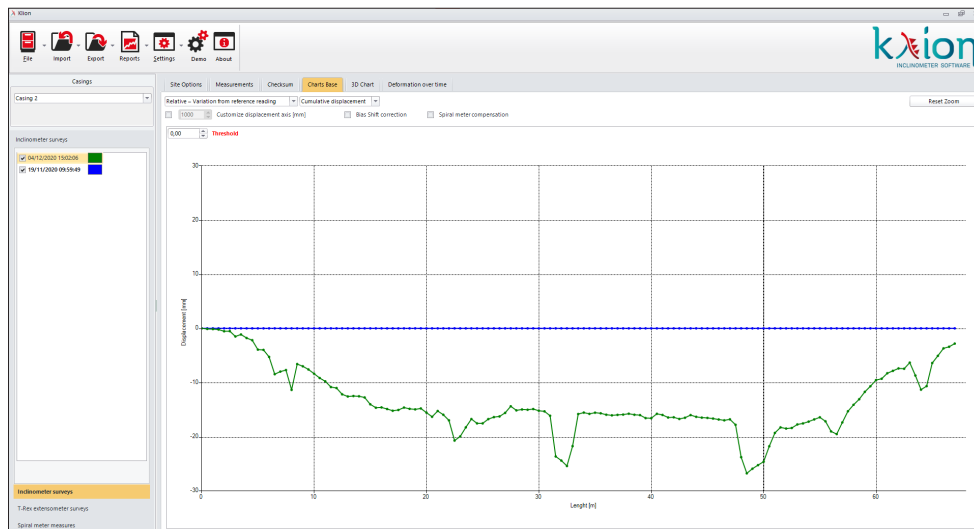

Inserting in “Measurements” page the “Tube entrance vertical offset,” the plot will be produced following this information. In the below example, the green curve has a vertical offset of the casing entrance of 5mm.

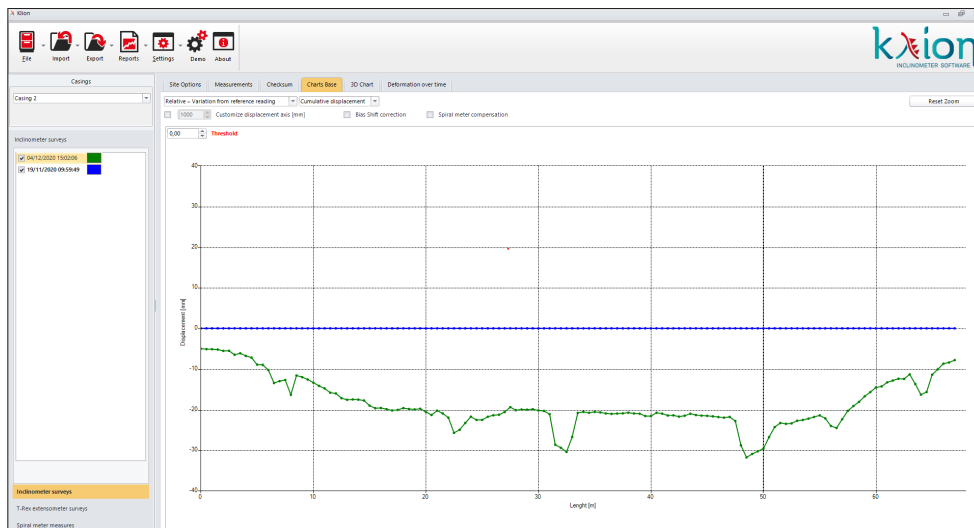

6.4 3D CHART

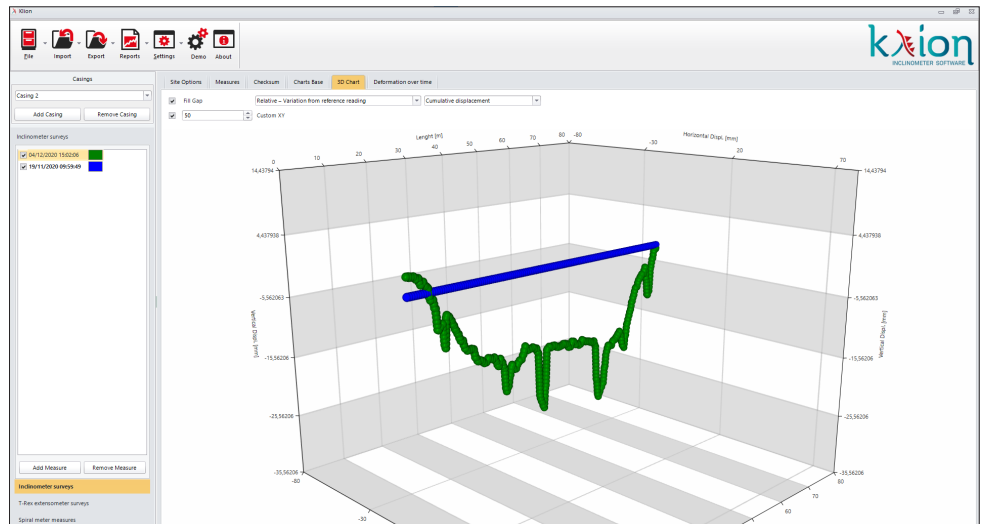

7. SPIRAL METER MEASUREMENTS PROCESSING

As explained in previous chapters, the program expects the introduction of casing twisting or “spiralling” to compensate the azimuth variation of the inclinometer casing grooves with the depth, due to casings manufacturing tolerances and/or to inclinometer columns installation.

The spiralling rotation direction must be established with reference to grooves orientation. By default it’s used the convention to consider as “positive” the spirallings where the casing turns, at different depths, clockwise compared to the head section.

The spirallings will be considered negative where the casing turns, at different depths, anti-clockwise compared to the head section.

The section **Spiral Meter Measurements section** is designed in the same way of the section **Inclinometer Measurements** so, as far as the menu and the different features are concerned, as data import (**B.R.A.IN** or **ARCHIMEDE**), applies what was reported in previous chapters.

The difference is that in the section **Spiral Meter Measurements** can be displayed only the “Measurements” pages (Raw values, Data elaboration and Probe status data) and the “Spiralometric charts” page.

The data are processed as indicated in the “SPIRAL METER MANUAL” and here following explained:

- calculate the mean of value of data collected at the same depth;
- mean values are then zeroed with reference to the value read at the first (upper) measuring interval, so that the initial reference value is zero
- for each depth “i” calculate the cumulative azimuth rotation. The cumulative azimuth at level 1 is zero. The cumulative azimuth at depth “i” is the sum of zeroed value at depth “i” and cumulative azimuth at depth “i-1”

Survey raw value page:

The screenshot shows the 'Survey Raw Values' page in the Klion Inclinometer Software. The interface includes a menu bar (File, Import, Export, Reports, Settings, Demo, About) and a toolbar. The main window is titled 'Spiral Meter Measure' and contains the following information:

- Site Options:** Casing: #1
- Spiral Meter Measure:**
 - Date/Time: 22/10/2020 11:17
 - 1st reading depth (m): 1.00
 - Temperature (°C): 18.65
 - Probe id (serial number): 1502358
 - Notes: (Bram - Serial 20200387)
 - Reading Interval (m): 1.00
 - Probe calibration date: 21/10/2020 13:53
 - Readings: 36
- Measure Values:**

Depth (m)	SPIRALOMETRIC DOWN (°)	SPIRALOMETRIC UP (°)
1.00	-0.19	0.34
2.00	-0.01	0.53
3.00	0.29	0.85
4.00	0.16	0.57
5.00	0.57	0.55
6.00	0.47	0.15
7.00	0.38	0.04
8.00	0.22	0.26
9.00	0.18	0.18
10.00	0.32	0.01
11.00	0.24	0.00
12.00	-0.14	-0.39
13.00	-0.14	-0.32
14.00	-0.29	-0.23
15.00	-0.25	0.41
16.00	0.09	0.37
17.00	1.77	2.40
18.00	0.46	-0.09
19.00	-0.03	0.15
20.00	0.28	0.34
21.00	-0.12	-0.38
22.00	-0.24	0.13
23.00	0.28	0.73

Data elaboration page:

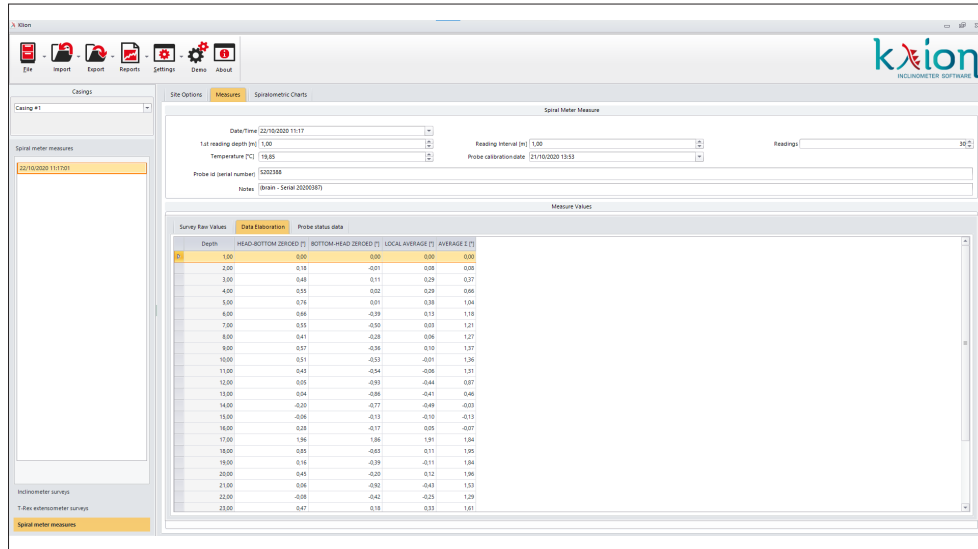

Measure Values

Depth	HEAD-BOTTOM ZEROED [°]	BOTTOM-HEAD ZEROED [°]	LOCAL AVERAGE [°]	AVERAGE [°]
1.00	0.00	0.00	0.00	0.00
2.00	0.18	-0.01	0.08	0.08
3.00	0.43	-0.11	0.29	0.37
4.00	0.55	-0.02	0.29	0.66
5.00	0.74	0.01	0.38	1.04
6.00	0.88	-0.28	0.13	1.18
7.00	0.55	-0.50	0.03	1.21
8.00	0.41	-0.28	0.06	1.27
9.00	0.37	-0.56	0.10	1.37
10.00	0.51	-0.33	-0.01	1.36
11.00	0.43	-0.54	-0.06	1.31
12.00	0.59	-0.39	-0.04	0.87
13.00	0.04	-0.86	-0.41	0.46
14.00	-0.20	-0.77	-0.49	-0.03
15.00	-0.04	-0.13	-0.10	-0.13
16.00	0.33	-0.17	0.03	-0.07
17.00	1.04	1.06	1.01	1.04
18.00	0.55	-0.83	0.11	1.05
19.00	0.14	-0.39	-0.11	1.04
20.00	0.43	-0.20	0.12	1.06
21.00	0.04	-0.82	-0.43	1.13
22.00	-0.08	-0.42	-0.23	1.29
23.00	0.47	0.18	0.33	1.61

Probe status data page:

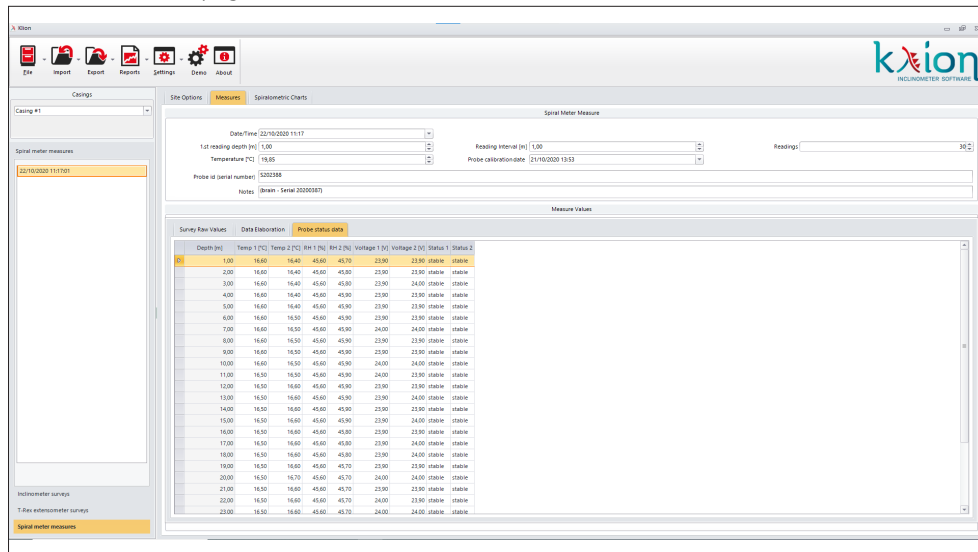

Probe status data

Depth [m]	Temp 1 [°C]	Temp 2 [°C]	RH 1 [%]	RH 2 [%]	Voltage 1 [V]	Voltage 2 [V]	Status 1	Status 2
1.00	16.60	16.40	45.60	45.70	23.90	23.90	stable	stable
2.00	16.60	16.40	45.60	45.80	23.90	23.90	stable	stable
3.00	16.60	16.40	45.60	45.90	23.90	24.00	stable	stable
4.00	16.60	16.40	45.60	45.90	23.90	23.90	stable	stable
5.00	16.60	16.40	45.60	45.90	23.90	23.90	stable	stable
6.00	16.60	16.50	45.60	45.90	23.90	23.90	stable	stable
7.00	16.60	16.50	45.60	45.90	24.00	24.00	stable	stable
8.00	16.60	16.50	45.60	45.90	23.90	23.90	stable	stable
9.00	16.60	16.50	45.60	45.90	23.90	23.90	stable	stable
10.00	16.60	16.50	45.60	45.90	24.00	24.00	stable	stable
11.00	16.50	16.50	45.60	45.90	24.00	23.90	stable	stable
12.00	16.50	16.60	45.60	45.90	23.90	23.90	stable	stable
13.00	16.50	16.60	45.60	45.90	23.90	24.00	stable	stable
14.00	16.50	16.60	45.60	45.90	23.90	23.90	stable	stable
15.00	16.50	16.60	45.60	45.90	23.90	24.00	stable	stable
16.00	16.50	16.60	45.60	45.90	23.90	23.90	stable	stable
17.00	16.50	16.60	45.60	45.90	23.90	24.00	stable	stable
18.00	16.50	16.60	45.60	45.80	23.90	24.00	stable	stable
19.00	16.50	16.60	45.60	45.70	23.90	23.90	stable	stable
20.00	16.50	16.70	45.60	45.70	24.00	24.00	stable	stable
21.00	16.50	16.60	45.60	45.70	23.90	23.90	stable	stable
22.00	16.50	16.60	45.60	45.70	24.00	23.90	stable	stable
23.00	16.50	16.60	45.60	45.70	24.00	24.00	stable	stable

KLION can also display the graphs of the spiral reading as “Local spiralling”, indicating the twisting at a certain depth, and as “Cumulative spiralling”, showing the cumulative twisting of the casing starting from the casing collar.

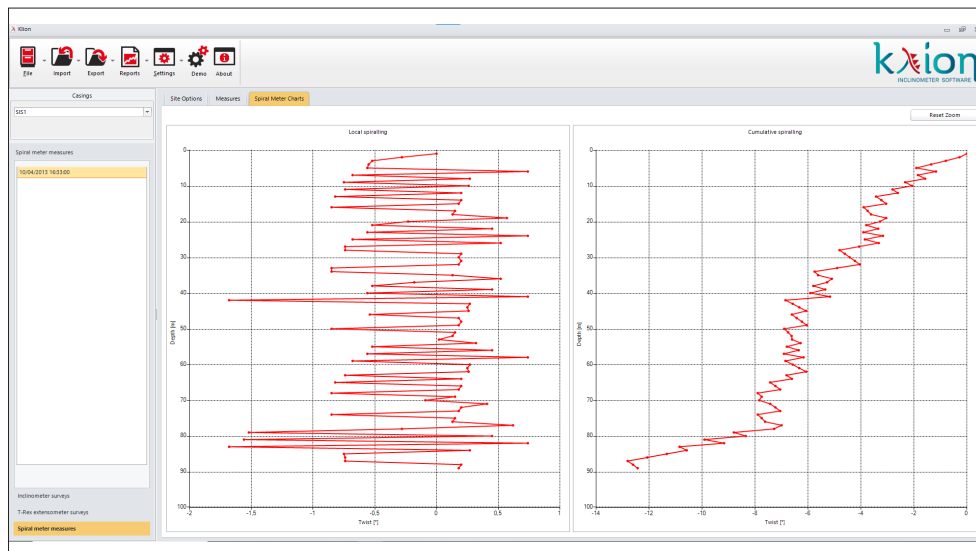

8. T-REX EXTENSOMETER PROCESSING

KLION allows to process and manage also extensometer surveys performed with T-Rex probe; the import is similar to the inclinometer readings. The T-Rex extensometer is an instrument designed to execute extensometer measurements using special inclinometer tubes supplied with reference magnetic rings located at every meter of casing. The T-Rex probe is supplied with two linear, high precision sensors.

The section **T-Rex Extensometer Surveys** is designed in the same way of the section **Inclinometer Surveys** so, as far as the menu and the different features are concerned, applies what was reported in previous chapters

In the section Measurements it's possible to display 3 screens:

Survey raw data: where are shown the measurements executed in the runs **"Bottom-Head"**, **"Head-Bottom"** and **"Average"**. It's shown also the value considered in the graph **"Data used for the processing"**. The data shown in this column is established by the choice made in the field **"Run Mode"** of measurement's properties and can differ among several T-Rex measurements.

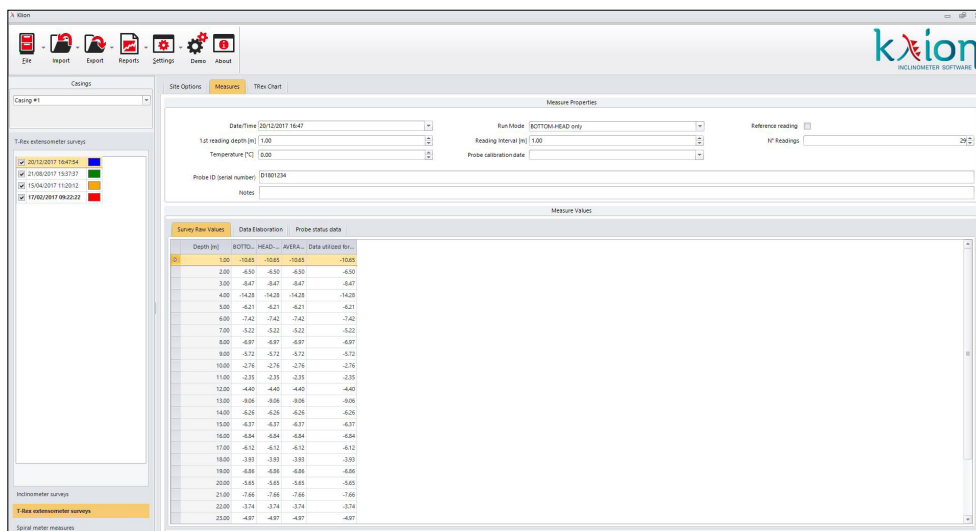

Depth (m)	BOTTOM-HEAD	HEAD-BOTTOM	AVERAGE	Data utilized for...
1.00	-0.645	-0.645	-0.645	-0.645
2.00	-0.50	-0.50	-0.50	-0.50
3.00	-0.47	-0.47	-0.47	-0.47
4.00	-0.428	-0.428	-0.428	-0.428
5.00	-0.21	-0.21	-0.21	-0.21
6.00	-0.742	-0.742	-0.742	-0.742
7.00	-0.221	-0.221	-0.221	-0.221
8.00	-0.97	-0.97	-0.97	-0.97
9.00	-0.72	-0.72	-0.72	-0.72
10.00	-0.276	-0.276	-0.276	-0.276
11.00	-0.25	-0.25	-0.25	-0.25
12.00	-0.445	-0.445	-0.445	-0.445
13.00	-0.06	-0.06	-0.06	-0.06
14.00	-0.26	-0.26	-0.26	-0.26
15.00	-0.97	-0.97	-0.97	-0.97
16.00	-0.54	-0.54	-0.54	-0.54
17.00	-0.12	-0.12	-0.12	-0.12
18.00	-0.93	-0.93	-0.93	-0.93
19.00	-0.84	-0.84	-0.84	-0.84
20.00	-0.55	-0.55	-0.55	-0.55
21.00	-0.766	-0.766	-0.766	-0.766
22.00	-0.74	-0.74	-0.74	-0.74
23.00	-0.97	-0.97	-0.97	-0.97

Data elaboration: here it's displayed the local displacement at the different depths and the sum of the displacements;

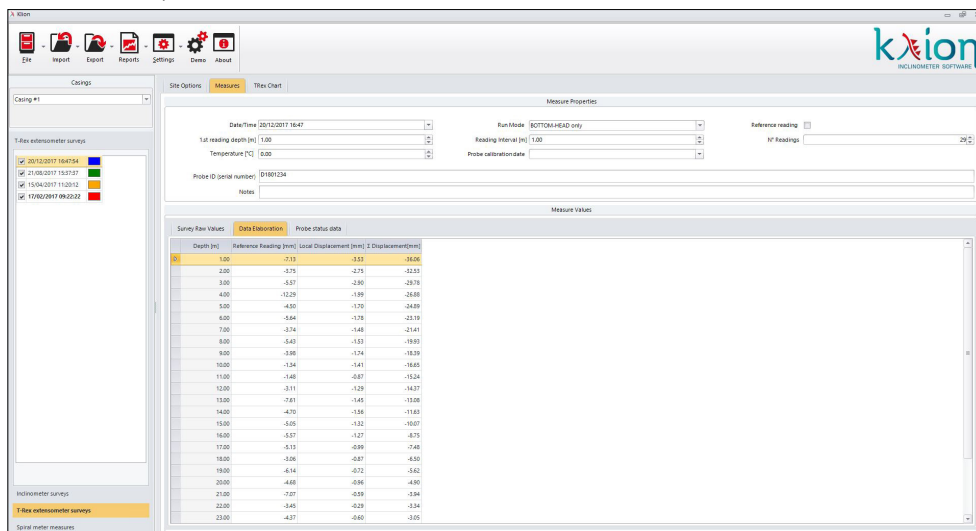

Depth (m)	Reference Reading (mm)	Local Displacement (mm)	Σ Displacement (mm)
1.00	-0.645	-0.645	-0.645
2.00	-0.50	-0.50	-0.50
3.00	-0.47	-0.47	-0.47
4.00	-0.428	-0.428	-0.428
5.00	-0.21	-0.21	-0.21
6.00	-0.742	-0.742	-0.742
7.00	-0.221	-0.221	-0.221
8.00	-0.97	-0.97	-0.97
9.00	-0.72	-0.72	-0.72
10.00	-0.276	-0.276	-0.276
11.00	-0.25	-0.25	-0.25
12.00	-0.445	-0.445	-0.445
13.00	-0.06	-0.06	-0.06
14.00	-0.26	-0.26	-0.26
15.00	-0.97	-0.97	-0.97
16.00	-0.54	-0.54	-0.54
17.00	-0.12	-0.12	-0.12
18.00	-0.93	-0.93	-0.93
19.00	-0.84	-0.84	-0.84
20.00	-0.55	-0.55	-0.55
21.00	-0.766	-0.766	-0.766
22.00	-0.74	-0.74	-0.74
23.00	-0.97	-0.97	-0.97

Probe status data: here are shown data recorded from **B.R.A.IN** system referring to T-Rex probe parameters.

In the **T-Rex Chart** is shown the graph where it's possible to choose whether to display the cumulated displacement curves or the local displacement curves, whether to have or not the "smoothing" of the graph's curves, what kind of Run Mode of the selected measurement to have. If you hover with the mouse on the graph, it will be shown the labels with the value of the measurements.

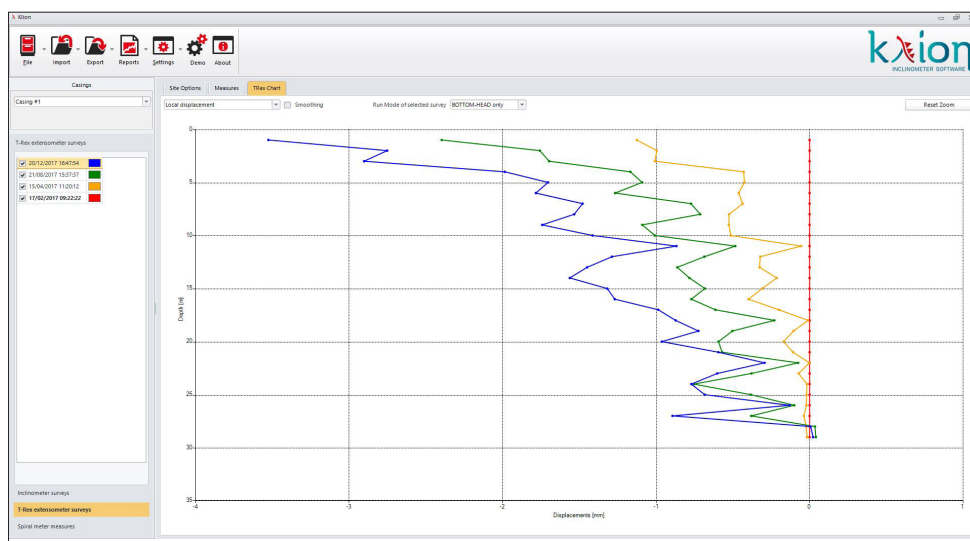

9. REPORTS

It's possible to create automatic reports selecting on the button "Reports".
it's possible to choose what kind of data to include in the automatic report:

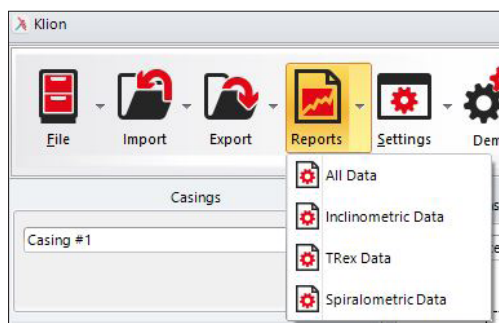

Once chosen the desired option, it will open an advanced Word Processor that allows to modify the report using all the typical features of this application.
The inserted data in the document are the ones chosen from the start menu or from the selected measurements and elaboration options. Changing the selected combination and clicking on "Refresh" the document will be reloaded with chosen data.
Once modified according to the requirements, the document can be saved, printed or exported in one of the available data (Word, Pdf, Excel, ecc...).

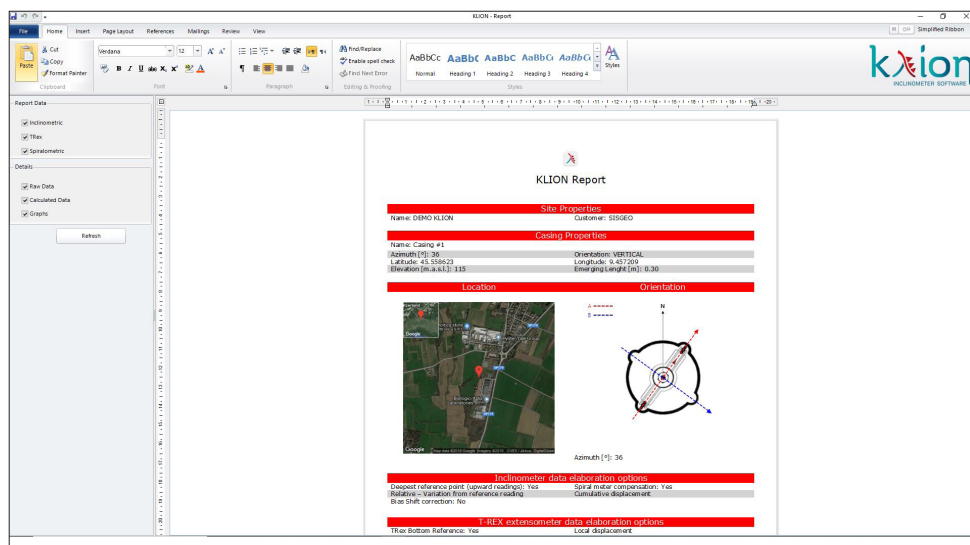

10. MEASUREMENT SYSTEM

As already briefly explained in paragraph 4.2.5, in the section “Options” it’s possible to choose the unit of measurement to be used.

You can choose between two measurement systems: metric and USA customary system.

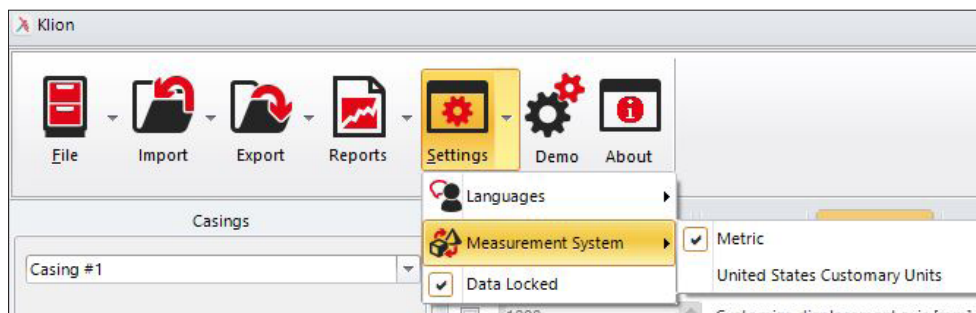

The measurements executed will be shown in the unit of measurement of the system chosen.

Switching from a system to another, the measurements won’t change in their content because it meant that they have been executed with the chosen system of measurement. On the contrary, in the processed data, switching from a system to another, the processed data will change because resulted from a math process.



APPENDIX 1

EXCEL FILE STRUCTURE WITH INCLINOMETER DATA EXPORT

During the export on Excel file, are exported not only the readings in raw format, but also all data from inclinometer's probe and measurement processing:

*Depth, reading A1, reading A3, reading A2, reading A4,
reading B1, reading B3, reading B2, reading B4,
checksum A1A3, checksum A2A4, checksum B1B3, checksum B2B4,
average A1A3, average A2A4, average B1B3, average B2B4,
reference reading North, reference reading East,
Relative movement towards North, Relative movement towards East,
Relative movement resulting, Azimuth Relative movement,
cumulative relative movement towards North, cumulative relative movement towards East,
cumulative relative movement resulting, Azimuth cumulative relative movement,
correction Bias-Shift towards North, correction Bias-Shift towards East,
correction Resulting Bias-Shift, Azimuth correction Bias-Shift,
Internal probe temperature first run, second run, third run, forth run,
Internal probe relative humidity first run, second run, third run, forth run,
Probe's power supply first run, second run, third run, forth run,
Measurement's stability state first run, second run, third run, forth run.*

Follows an example of export with only the main values displayed. The others are available sliding the Excel file towards right.

	A	B	C	D	E	F	G	H	I	J	K
	Depth [m]	A1 [digit]	A3 [digit]	B1 [digit]	B3 [digit]	Check A1A3 [digit]	Check B1B3 [digit]	Average A1A3 [digit]	Average B1B3 [digit]	Reference North [mm]	Reference East [mm]
1											
2	1	-87	8	106	-78	-79	28	47.5	92	4.238559337	-3.74978196
3	2	-26	52	112	-88	26	24	39	100	3.52347163	-3.101334129
4	3	166	-129	71	-53	37	18	147.5	62	-5.354365217	-6.591767451
5	4	235	-221	35	-18	14	17	228	26.5	-8.794438926	-8.20550693
6	5	179	-145	-2	23	34	21	162	12.5	-7.110664622	-4.480409985
7	6	237	-202	36	-19	35	17	219.5	27.5	-8.152116668	-7.499574685
8	7	227	-201	-26	42	26	16	214	34	-9.578845387	-4.805865797
9	8	274	-254	25	-13	20	12	264	19	-10.19685531	-7.696345148
10	9	344	-312	67	-47	32	20	328	57	-12.08955139	-11.47808047
11	10	339	-319	19	-1	20	18	329	10	-13.28758935	-9.360828969
12	11	379	-357	74	-59	22	15	368	66.5	-13.48871084	-12.94595709
13	12	260	-224	32	-20	36	12	242	26	-10.0444936	-7.429016566
14	13	351	-326	75	-60	25	15	338.5	67.5	-12.61728799	-11.82728493
15	14	350	-318	115	-100	32	15	334	107.5	-11.03551733	-13.10955669
16	15	319	-313	70	-41	6	29	316	55.5	-12.28605706	-11.15119061
17	16	308	-286	84	-70	22	14	297	77	-10.07296135	-11.04062723
18	17	381	-337	41	-17	44	24	359	29	-14.81206629	-10.91241573
19	18	362	-352	91	-61	10	30	357	76	-12.14974471	-12.67778385
20	19	362	-331	74	-53	31	21	346.5	63.5	-12.60266971	-12.0416295
21	20	353	-325	61	-42	28	19	339	51.5	-12.40329686	-11.37487948
22	21	363	-335	95	-77	28	18	349	86	-12.05565234	-12.28929546
23	22	419	-401	78	-52	18	26	410	65	-15.88714455	-13.71312831
24	23	403	-411	113	-30	-8	83	407	71.5	-16.99610367	-13.22473857
25	24	382	-353	101	-78	29	23	367.5	89.5	-12.95649829	-13.1198
26	25	400	-368	110	-79	32	31	384	94.5	-13.59514288	-14.45033183
27	26	423	-393	33	-7	30	26	408	20	-16.21397011	-12.09001337
28	27	411	-395	52	-25	16	27	403	38.5	-16.26052648	-12.19509239
29	28	447	-411	50	-19	36	31	429	34.5	-16.96075441	-12.45351556
30	29	440	-409	18	4	31	22	424.5	11	-18.00496935	-11.33740287
31	30	443	-419	44	-20	24	24	431	32	-17.60149252	-12.51768592
32	31	458	-427	59	-32	31	27	442.5	45.5	-17.32970758	-13.84934512
33	32	495	-462	35	-9	33	26	478.5	22	-19.9681012	-13.53308765
34	33	525	-492	44	-13	33	31	508.5	28.5	-20.63118385	-14.48928062
35	34	546	-512	15	9	34	24	529	12	-22.95283574	-13.44357956
36	35	536	-506	-3	31	30	28	521	17	-22.82188945	-12.48046419
37	36	557	-528	-7	31	29	24	542.5	19	-23.65577886	-13.19622585
38	37	610	-575	-15	39	35	24	592.5	27	-26.11854713	-13.89186798
39	38	552	-522	-52	81	30	29	537	66.5	-24.858656	-10.7655572
40	39	568	-535	-27	55	33	28	551.5	41	-24.49774148	-12.30825587
41	40	636	-603	-30	64	33	26	610	51.5	-28.10431130	-13.27699646

APPENDIX 2

IMPORT INCLINOMETER DATA FROM OTHER SYSTEMS

With KLION software it's possible to process and turn into graph inclinometer data collected also with measurement system not supplied by Sisgeo.

The import operation relies on a file Excel, to be drawn up, including the data to be processed.

The Excel file must be necessarily structured as shown in the following picture:

	A	B	C	D	E	F	G	H	I
1	Depth [m]	A1 [digit]	A3 [digit]	A2 [digit]	A4 [digit]	B1 [digit]	B3 [digit]	B2 [digit]	B4 [digit]
2	0.5	0	0	0	0	0	0	0	0
3	1	0	0	0	0	0	0	0	0
4	1.5	0	0	0	0	0	0	0	0
5	2	0	0	0	0	0	0	0	0
6	2.5	0	0	0	0	0	0	0	0
7	3	0	0	0	0	0	0	0	0
8	3.5	0	0	0	0	0	0	0	0
9	4	0	0	0	0	0	0	0	0
10	4.5	0	0	0	0	0	0	0	0
11	5	0	0	0	0	0	0	0	0

The operator must replace "zero" with the inclinometer values collected on field.

If, for example, the measurements have been executed on two grooves only (A1B1, A3B3), in the A2, A4, B2 and B4 columns must be inserted the value "0" (zero). If not inserted, the program won't be able to recognize the file.

In order to import the data from the drawn up Excel file, please proceed as follows:

- Open KLION and create a new Project (File --> New);
- Click on "Options" and remove the selection on "Data locked";
- Click on tab "Site Options" and insert all data needed;
- Click on "Add measurement" in the lower part left from the screen;
- Click on tab "Measurements" and insert the following MANDATORY parameters:

- * Date/time (insert by clicking on the key on the right of the screen)
- * Reading sequence (usually A1B1 A3B3 for readings on two guides)
- * N° readings (very important: it's the number of measurements executed in the casing. For example, in case of readings every meter, first measurement taken at -1m, last measurement at -30m, the value to insert is 29)
- * Reading interval (it's the distance between a measurement and the other, usually 0.5m or 1m)
- * First reading depth (it defines the depth of the measurement point closest to the surface)
- * Convention Ch A and Ch B: for the SISGEO probe is -1

- Click on tab "Measurements"; then click on "From Excel" and select the file to be imported (drawn up as previously explained);
- Right after the import, KLION program has already calculated all the check-sum values and processing.

Once imported all the measurements from a casing, define the reference measurement as explained in this manual.

APPENDIX 3

CHANGE LABELS WITHIN KLION SOFTWARE

In order to allow the rename of some labels in the software, the option “DATA LOCKED” in the “SETTINGS” menu shall be unselected.

The rename of the labels could be useful for example in a project where the casing is installed in a diaphragm wall and the reference keyway is perpendicular to the wall longitudinal direction. In this case the names of “NORTH DEFORMATIONS” and “EAST DEFORMATION” plots could be better renamed e.g. as “DEFORMATION TOWARDS EXCAVATION” and “TRANSVERSE DEFORMATION”. To change the labels proceed in this way:

1 - go with the cursor on the label to be changed and use push the CTRL button with the right-click of your mouse. The following message window will be opened:

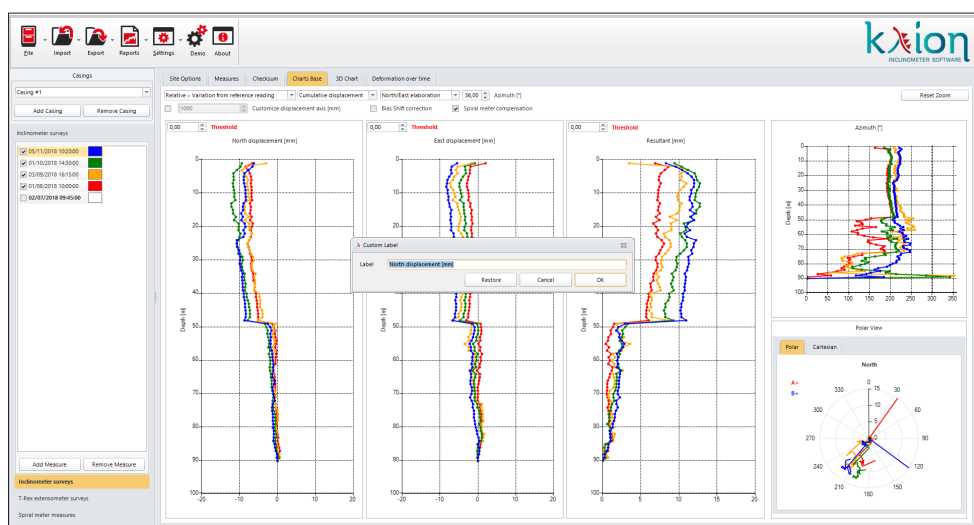

2 - type in the message window the new label, e.g. “Deformation toward excavation [mm]”:

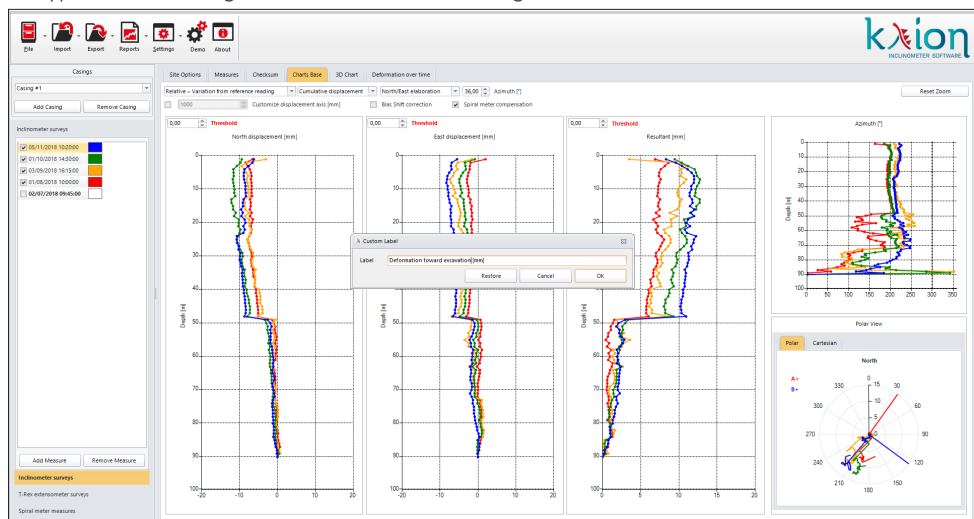

3 - Select OK and the label will be changed:

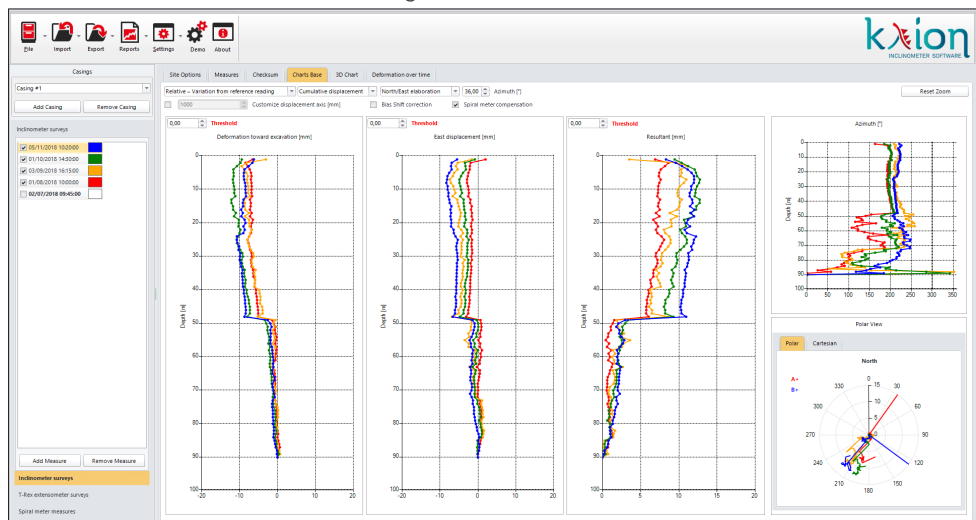

4 - To change the name of the “East displacement” plot, proceed in the same way and the results will be the following:

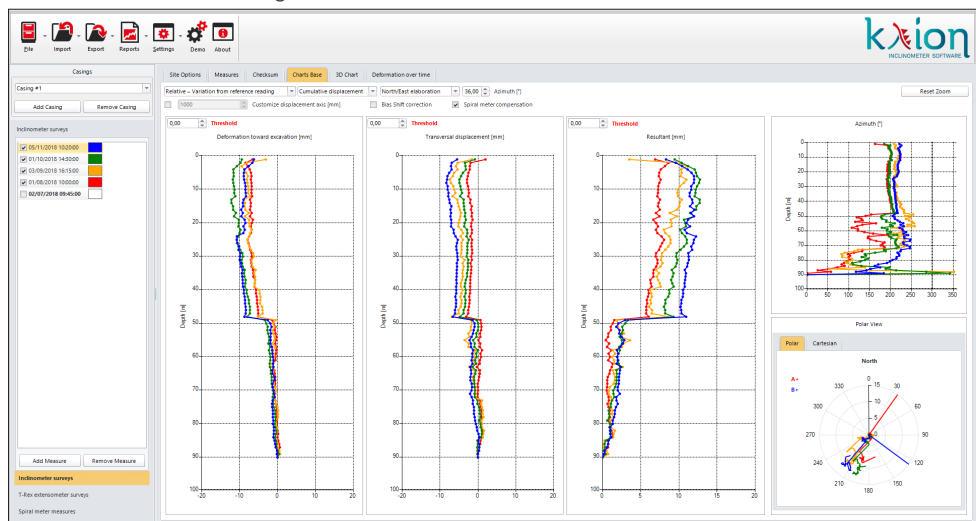

5 - If the original label shall be ripristinated, proceed with the right click + CTRL and in the message window select “Restore” and than OK.

APPENDIX 4

NEW PROBE OFFSET DATA PROCESSING

The “New Probe Offset” data processing, allows to connect the readings taken with a new inclinometer probe with a series of curve and processing coming from a previous inclinometer probe.



NOTE: the main assumption utilized with this data processing is that there was NO movement between the selected measurement for the “new probe offset” and the previous reading, therefore they are considered coincident.



NOTE: the International Standard ISO 18674-3 does not take in account this opportunity.



NOTE: the international publications suggest to do not use such approach: the correct procedure when starting measurements on an existing casing with a new probe is to start a new data analysis and processing.

Here below an example of “New Probe Offset” application.

Consider that in the next picture, the reading of 05/08/2014 is taken with a new inclinometer probe, different from the inclinometer probe utilized for all the previous readings.

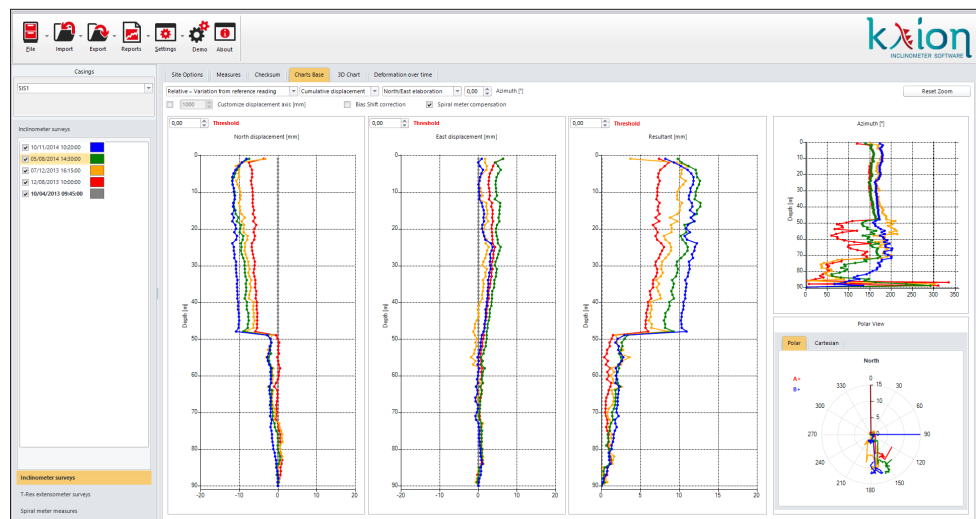

To apply this processing, select the reading taken with the new probe and then select “Measurements” page. In this page, select the “New probe offset” option. A warning windows will be displayed. Selecting “Yes” the option will be applied. Selecting “No” this processing will be not applied.

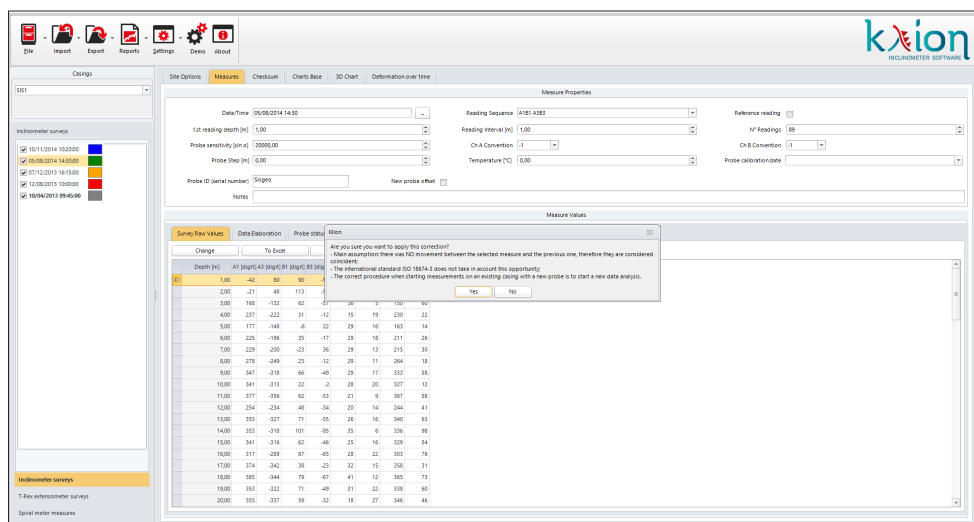

Depth [m]	A1 [µm]	B1 [µm]	B2 [µm]	B3 [µm]	B4 [µm]
1.00	-42	80	90		
2.00	-21	-48	113	-6	
3.00	165	-151	62	-67	-28
4.00	237	-222	31	-12	15
5.00	177	-148	6	22	29
6.00	225	-186	35	-17	29
7.00	329	-250	-23	36	29
8.00	278	-249	23	-12	29
9.00	347	-318	66	-49	29
10.00	341	-313	22	-2	29
11.00	377	-356	62	-33	21
12.00	254	-234	40	-34	20
13.00	353	-327	71	-20	28
14.00	353	-318	101	-95	33
15.00	341	-316	62	-46	25
16.00	317	-289	87	-45	28
17.00	374	-342	38	-23	32
18.00	385	-344	79	-47	41
19.00	353	-322	71	-49	31
20.00	355	-337	59	-32	18

After selecting the “New probe offset,” the measurement where the option is selected will be marked in yellow and the next measurements will be marked in green. In “Chart base” page, the measurement where this option is selected will be not drawn because this reading is used only to calculate the offset. The offset will be applied to all the next readings.

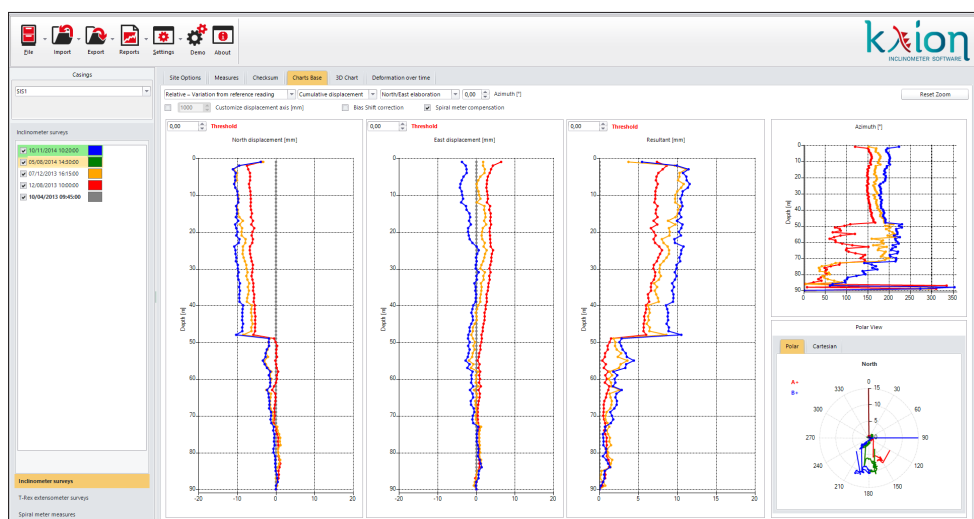

NOTE: all the future readings must be made with the new probe utilized in the reading where the “New probe offset” is selected.

APPENDIX 5

DEFINITION OF "MEASURE LENGTH" AND "DEPTH" FOR CORRECT DATA INTERPRETATION - **EXAMPLE OF SURVEY USING PULLEY AND CABLE STOP**

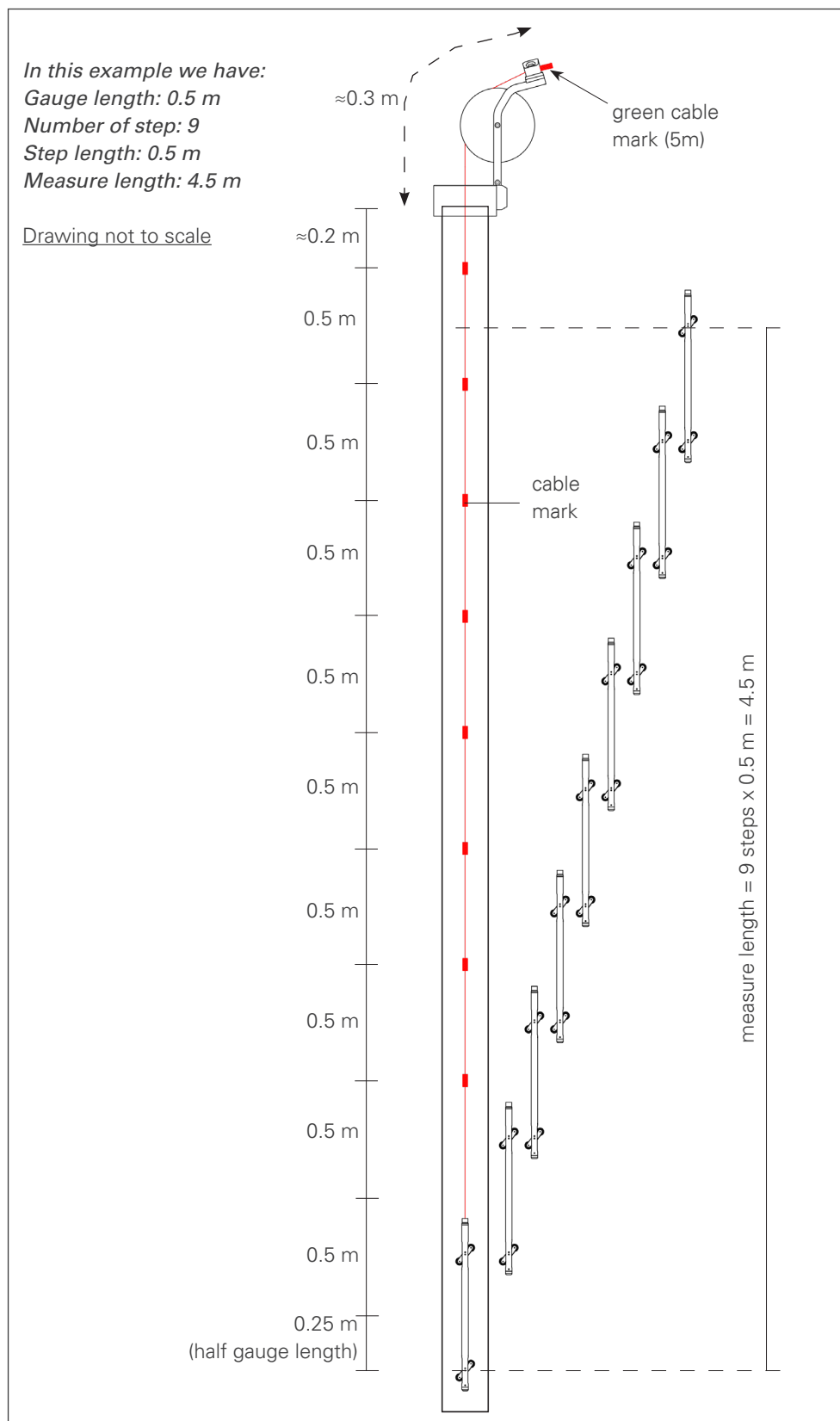

APPENDIX 6

DEFINITION OF "MEASURE LENGTH" AND "DEPTH" FOR CORRECT DATA INTERPRETATION - **EXAMPLE OF SURVEY WITHOUT PULLEY**

In this example we have:
 Gauge length: 0.5 m
 Number of step: 9
 Step length: 0.5 m
 Measure length: 4.5 m

Drawing not to scale

